

BETA LAB NO. M10198, TESORO LS2 AND LS2/CS2 TEE FINDINGS PART: 6600-E HEAT EXCHANGER, LS2 22 IN, 36.5 IN MOUNTS, LS2 T2L SEM FRACTOGRAPHY AND PART 22 LS2-CS2 TEE FINDINGS PARTS 16-1 AND 22	TESORO REFINING AND MARKETING COMPANY ANACORTES REFINERY 10200 W. MARCH POINT ROAD T91WA4428 ANACORTES, WA 98221	CUSTOMER P.O. No.: 4501667904
		DATE: OCTOBER 13, 2010
		PAGE 1 OF 56

LABORATORY REPORT

CONTACT:	JIM MCVAY
ISSUED BY:	MARK BRIDAVSKY
TELEPHONE EXTENSION:	440-604-9862
MAIL STOP:	A- BETA
REVIEWED BY :	JEFF BLOUGH

REPORT ISSUED TO:

Jim McVay	Robert J. Hall	Robert Parker
------------------	-----------------------	----------------------

SAMPLE DESCRIPTION: A heat exchanger failed and a test protocol was developed for the failure analysis of the component. This test protocol and its addendum, as of this date and contained in Attachment 1, were developed and signed by Tesoro Companies, Division of Occupational Safety and Health and U.S. Chemical Safety Board. FirstEnergy BETA Laboratory was selected as the referee test laboratory to perform the testing requirements of the test protocol. The test protocol was not specific as to the test samples to be removed from the heat exchanger or the test locations/test parameters for each specific test within the test sample. Therefore it was agreed

“The laboratory, acting as a referee laboratory, will be supplied the locations to take the test samples and the type of test and test parameters to be performed at each location on the test sample, i.e. magnification, hardness load/test method. The signatory parties or their technical representatives that are present in the laboratory at the time shall make those decisions and give that information directly to the laboratory. Comments from other technical experts will be considered and factored into the signatory parties or their technical representative’s decisions but all decisions on protocol or samples shall remain as decisions of the signatory parties or their representatives.”

Additionally it was determined that BETA laboratory as a referee test laboratory is to report the data obtained but not give any interpretation or conclusion on any data, or on details in the photo.

On June 5, 2010 the heat exchanger arrived at Halvorsen Company’s warehouse, in a June 11, 2010 meeting locations were selected for sample removal and on June 12, 2010 samples were cut by Halvorsen for submittal to BETA laboratory. The results of the receipt inspection for the heat exchanger at Halvorsen Companies warehouse are contained in FirstEnergy’s report titled M10198- Receipt dated July 30, 2010.

This report concerns evaluation of the following parts: LS2 samples at about 22 inches and about 36 ½ inches from the CS3 weld toe, LS2 sample T2L SEM where the crack was opened in the Laboratory and the fracture surface evaluated in SEM, as well as additional tests of Part 22 (approximate location is 84 inches from CS3 toe, at the Tee of LS2 and CS2).

This interpretive report is a result of testing/analysis derived from material, information and/or specifications furnished by the customer and is confidential and is intended for the customer only. If you are receiving it in error, please advise immediately. Further, you are prohibited from disclosing, copying, distributing or using any of this information without written approval from Beta Lab. This report shall not be reproduced except in its entirety and, in any case, without prior written approval from Beta Lab. Except for such obligations as are set forth in the Agreement between Beta Lab and its customer for whom this work has been performed, neither the party preparing this report nor any person acting on its behalf: Makes any warranty or representation, express or implied, including merchantability or fitness for a particular purpose, with respect to the accuracy, completeness or usefulness of the information contained in this report, or that the use of any information, apparatus method or process disclosed from this report does not infringe upon privately owned rights or intellectual property; or Assumes any liability with respect to the use of, or for damages, including consequential or punitive damages, resulting from the use of, any information, apparatus, method or process disclosed in this report.

BETA LAB NO. M10198, TESORO LS2 AND LS2/CS2 TEE FINDINGS PART: 6600-E HEAT EXCHANGER, LS2 22 IN, 36.5 IN MOUNTS, LS2 T2L SEM FRACTOGRAPHY AND PART 22 LS2-CS2 TEE FINDINGS PARTS 16-1 AND 22	TESORO REFINING AND MARKETING COMPANY ANACORTES REFINERY 10200 W. MARCH POINT ROAD T91WA4428 ANACORTES, WA 98221	CUSTOMER P.O. No.: 4501667904
		DATE: OCTOBER 13, 2010
		PAGE 2 OF 56

LABORATORY REPORT

This report is the tenth of a series of the reports on the failed parts of the 6600E heat exchanger. The LS# and CS# refer to longitudinal and circumferential weld seams respectively, while the part number refers to the chain of custody number. Below is the list of the previously issued reports:

#	REPORT	DATE
1	M10198 Tesoro Receipt Inspection	July 29, 2010
2	M10198 Tesoro LS3 Bottom Findings	July 30, 2010
3	M10198 Tesoro CS4 Findings	August 5, 2010
4	M10198 Tesoro LS2-CS3 Tee Indications Findings	August 13, 2010
5	M10198 Tesoro CS4-01/LS3 Bottom Findings	August 25, 2010
6	M10198 Tesoro LS1-CS2 LS2-CS3 CS4 Mechanical Tests	August 27, 2010
7	M10198 Tesoro CS4-01/LS3 Bottom Findings, Rev. 1	September 20, 2010
8	M10198 Tesoro CS03 Top Findings	September 20, 2010
9	M10198 Tesoro LS3 Bottom – Fractography and 19 M-5 Mount	September 23, 2010

TEST PERFORMED:

Samples at about 22 inches and about 36 ½ inches were metallographically evaluated and the results are on Figures 5 through 16. LS2 T2L SEM sample was evaluated in SEM after the crack was open in the Laboratory. The results are on Figures 18 through 21.

The tests on the Part 22 of the exchanger in this report included visual examination, photomicroscopy of two cross sections removed from the LS2 and CS2 weld joints, chemical analysis of CS-2 and LS2 welds at both the ID and OD surfaces and hardness traverses of base and weld metals on both samples (both welds were previously chemically tested and result reported in **M10198-LS3 BOTTOM FINDINGS JULY 30, 2010** and **M10198- CS4 FINDINGS, AUGUST 5, 2010**, **M10198 Tesoro LS2-CS3 Tee Indications Findings, August 13, 2010**, **M10198 Tesoro LS1-CS2 LS2-CS3 CS4 Mechanical Tests, August 27, 2010**. T2L sample was hardness tested previously as well). All relevant previous data are transferred from previous reports.

The details of the apparatus utilized and the test procedures are given in Table 1 and Attachment 2.

TEST RESULTS: The heat exchanger weld seams had been previous labeled as shown in Figure 1 and the same labeling was used for this report. The subjects of this report are samples from LS2 at about 22 inches and about 36 ½ inches from the CS3 weld toe (Figures 5 through 16), Fractography of the T2L SEM sample in the SEM (Figures 18 through 21), as well as the Part 22 containing the T joint of welds LS2 and CS2 (Figures 25 through 33). All sample locations as well as the scopes of the evaluation were chosen by others. The microstructure of the samples in mounts from LS2 (at 22", 36 ½", T2L SEM, and CS2-A and LS2-A) were photographed and the results are in Figures 5 through 30. Vickers 500 g load

BETA LAB NO. M10198, TESORO LS2 AND LS2/CS2 TEE FINDINGS PART: 6600-E HEAT EXCHANGER, LS2 22 IN, 36.5 IN MOUNTS, LS2 T2L SEM FRACTOGRAPHY AND PART 22 LS2-CS2 TEE FINDINGS PARTS 16-1 AND 22	TESORO REFINING AND MARKETING COMPANY ANACORTES REFINERY 10200 W. MARCH POINT ROAD T91WA4428 ANACORTES, WA 98221	CUSTOMER P.O. No.: 4501667904
		DATE: OCTOBER 13, 2010
		PAGE 3 OF 56

LABORATORY REPORT

traverses micro-hardness on CS2-A sample were measured and the results are in Tables 4 and 5, and Figures 31 through 33 (the LS2 hardness was measured in previous report, see Tables 3 and 5). The chemical analysis of both samples were performed and reported in previous reports. The results are in Table 6.

The largest depth of the damage penetration in the LS2-A sample was measured as 2.68 mm from I.D.

TABLE 1
TESTS PERFORMED IN THIS REPORT
 (See Attachment 2 for Test/Equipment Specifications)

TEST	METHOD OR INSTRUMENT	PERFORMED BY	LOCATION, DATE	RESULTS LOCATION
VISUAL EXAMINATION	LECO SZH STEREO MACROSCOPE OR PORTRAIT CAMERA	J. BLOUGH AND M. BRIDAVSKY	BETA, VARIOUS	TEST RESULTS
SEMI-MACRO VICKERS	INSTRON TUKON 2100B HARDNESS TESTER, MODEL T2100BR1942	M. TASCAR	BETA, 10/2/2010	TABLE 4&5, FIGURES 31-33
OPTICAL METALLOGRAPHY	LECO PMG-3 OPTICAL MICROSCOPE	M. BRIDAVSKY	BETA, 9/28/2010	FIGURES 5-16, 25-30
FRACTOGRAPHY	CAMSCAN SCANNING ELECTRON MICROSCOPE WITH IXRF EDS2000 ENERGY DISPERSIVE X-RAY SPECTROMETER	C. HOLP	BETA, VARIOUS	FIGURES 18-21
LINEAR MEASUREMENTS	LECO PMG-3 OPTICAL MICROSCOPE WITH BUEHLER OMNIMET SYSTEM	M. BRIDAVSKY	BETA, 9/28/2010	TEST RESULTS

TABLE 2
ROCKWELL (HRB) HARDNESS MEASUREMENTS
ON PLATE CROSS SECTIONS
 (THE DATA ARE FROM PREVIOUS REPORTS: M10198-LS3 BOTTOM FINDINGS JULY 30, 2010, M10198- CS4 FINDINGS, AUGUST 5, AND 2010; M10198 Tesoro LS2-CS3 Tee Indications Findings, August 13, 2010)

SAMPLE IDENTIFICATION	HARDNESS, HRB			
	MINIMUM	MAXIMUM	AVERAGE	NUMBER OF INDENTATIONS
CAN 1	81.4	84.4	82.7	7
CAN 2	82.3	83.5	83.1	7

BETA LAB NO. M10198, TESORO LS2 AND LS2/CS2 TEE FINDINGS PART: 6600-E HEAT EXCHANGER, LS2 22 IN, 36.5 IN MOUNTS, LS2 T2L SEM FRACTOGRAPHY AND PART 22 LS2-CS2 TEE FINDINGS PARTS 16-1 AND 22	TESORO REFINING AND MARKETING COMPANY ANACORTES REFINERY 10200 W. MARCH POINT ROAD T91WA4428 ANACORTES, WA 98221	CUSTOMER P.O. No.: 4501667904
		DATE: OCTOBER 13, 2010
		PAGE 4 OF 56

LABORATORY REPORT

Table 3
MICRO-HARDNESS MEASUREMENTS MOUNT T2L LS2, VICKERS 500g (HV⁵⁰⁰)
(THE DATA ARE FROM PREVIOUS REPORT M10198 Tesoro LS2-CS3 Tee Indications Findings,
August 13, 2010)

T2L OD Line HV	Location	T2L Cusp Line HV	Locations	T2L ID Line HV	Locations
178	BM	167	BM	173	BM
177	BM	167	BM	184	BM
178	BM	184	BM	167	BM
165	BM	165	BM	175	BM
193	HAZ FG	183	HAZ FG	180	HAZ FG
197	HAZ FG	182	HAZ FG	180	HAZ FG
189	HAZ FG	183	HAZ FG	187	HAZ FG
207	HAZ FG			181	HAZ FG
219	HAZ CG			192	HAZ Finer FG
229	HAZ CG			185	HAZ Finer FG
218	HAZ CG			186	HAZ Finer FG
217	HAZ CG			192	HAZ Finer FG
183	Weld	175	Weld	172	Weld
172	Weld	169	Weld	171	Weld
196	Weld	162	Weld	166	Weld
183	Weld	168	Weld	161	Weld
172	Weld	176	Weld		
181	Weld	170	Weld		
225	HAZ CG	182	HAZ FG	190	HAZ Finer FG
226	HAZ CG	180	HAZ FG	197	HAZ Finer FG
218	HAZ CG	175	HAZ FG	191	HAZ Finer FG
242	HAZ CG	178	HAZ FG	195	HAZ Finer FG
201	HAZ FG			182	HAZ FG
200	HAZ FG			185	HAZ FG
198	HAZ FG			186	HAZ FG
205	HAZ FG			189	HAZ FG
177	BM	172	BM	181	BM
178	BM	178	BM	186	BM
173	BM	179	BM	173	BM
163	BM	191	BM		

Notes: BM = Base Metal, HAZ = Heat Affected Zone, CG = coarse grain, FG = fine grain

BETA LAB NO. M10198, TESORO LS2 AND LS2/CS2 TEE FINDINGS PART: 6600-E HEAT EXCHANGER, LS2 22 IN, 36.5 IN MOUNTS, LS2 T2L SEM FRACTOGRAPHY AND PART 22 LS2-CS2 TEE FINDINGS PARTS 16-1 AND 22	TESORO REFINING AND MARKETING COMPANY ANACORTES REFINERY 10200 W. MARCH POINT ROAD T91WA4428 ANACORTES, WA 98221	CUSTOMER P.O. No.: 4501667904
		DATE: OCTOBER 13, 2010
		PAGE 5 OF 56

LABORATORY REPORT

TABLE 4

**MICRO-HARDNESS VICKERS 500g (HV⁵⁰⁰) MEASUREMENTS
 OF TRAVERSES ON CS2 SAMPLE (FIGURE)
 See Graphs on Figure**

Line	Zone	Hardness, HV ⁵⁰⁰			Number of Indentations
		Minimum	Maximum	Average	
OD	Can 1 BM	155	197	177	10
	Can 1 HAZ	167	239	202	8
	Weld	157	195	176	52
	Can 2 HAZ	176	220	202	9
	Can 2 BM	160	186	171	10
Cusp	Can 1 BM	140	181	167	11
	Can 1 HAZ	160	182	171	6
	Weld	155	170	162	13
	Can 2 HAZ	165	182	175	3
	Can 2 BM	153	177	164	11
ID	Can 1 BM	167	181	173	11
	Can 1 HAZ	172	201	184	5
	Weld	168	186	177	22
	Can 2 HAZ	184	232	204	12
	Can 2 BM	159	187	173	12

TABLE 5

**SUMMARY OF MICRO-HARDNESS MEASUREMENTS
 FROM TABLES 3 and 4
 VICKERS 500g (HV⁵⁰⁰)**

Location	LS2	CS2
Base Metal Can 2	163-191	153-187
HAZ Can 2 one side	180-229	165-232
HAZ Can 2 other side	175-226	NA
HAZ – Can 1	NA	160-239
Weld Metal	161-196	155-195
Base Metal – Can 1	NA	140-197
HAZ - heat Affected Zone NA – not applicable		

BETA LAB NO. M10198, TESORO LS2 AND LS2/CS2 TEE FINDINGS PART: 6600-E HEAT EXCHANGER, LS2 22 IN, 36.5 IN MOUNTS, LS2 T2L SEM FRACTOGRAPHY AND PART 22 LS2-CS2 TEE FINDINGS PARTS 16-1 AND 22	TESORO REFINING AND MARKETING COMPANY ANACORTES REFINERY 10200 W. MARCH POINT ROAD T91WA4428 ANACORTES, WA 98221	CUSTOMER P.O. No.: 4501667904
		DATE: OCTOBER 13, 2010
		PAGE 6 OF 56

LABORATORY REPORT

TABLE 6
CHEMICAL ANALYSIS FOR BASE METAL AND WELD DEPOSITS
 (THE DATA ARE FROM PREVIOUS REPORTS M10198-LS3 BOTTOM FINDINGS JULY 30, 2010, M10198- CS4 FINDINGS, AUGUST 5, 2010, M10198 Tesoro LS2-CS3 Tee Indications Findings, August 13, 2010, and M10198 Tesoro LS1-CS2 LS2-CS3 CS4 Mechanical Tests, August 27, 2010)

SAMPLE IDENTIFICATION	CHEMICAL COMPOSITION, WT. %											
	C	SI	P	S	MN	NI	CR	MO	V	CU	CO	AL
CAN1	0.28	0.24	0.01	0.024	0.62	0.12	0.13	0.03	<0.001	0.18	0.01	0.005
CAN2	0.259	0.23	0.008	0.019	0.59	0.12	0.12	0.02	<0.001	0.18	0.01	0.01
SA- 515 GRADE 70	0.31	0.13-0.45	0.035 MAX	0.035 MAX	1.30 MAX	NS	NS	NS	NS	NS	NS	NS

▲ N 0.10 MAX MEASURED 0.04

LS2 ID SURFACE	0.13	0.54	0.011	0.018	1.15	0.05	0.07	0.01	0.002	0.14	0.01	0.010
LS2 OD CROWN	0.09	0.49	0.011	0.021	1.12	0.07	0.08	0.02	0.001	0.04	0.01	0.005
17 CS2 ID WELD SURFACE	0.11	0.57	0.015	0.021	1.22	0.06	0.10	0.01	0.002	0.23	0.01	0.007
17 CS2 OD CROWN	0.08	0.57	0.011	0.017	1.16	0.05	0.07	0.01	0.002	0.15	0.01	0.007
SFA 5.1 (E7016, E7018)*	NS	0.75 MAX	NS	NS	1.60 MAX	0.30 MAX	0.20 MAX	0.30 MAX	0.08 MAX	NS	NS	NS
SFA 5.17 (EM11K)	0.07-0.15	0.65-0.85	0.030 MAX	0.025 MAX	1.00-1.50	NS	NS	NS	NS	0.35	NS	NS
SFA 5.17 (EL12)	0.04-0.14	0.10 MAX	0.030 MAX	0.030 MAX	0.25-0.60	NS	NS	NS	NS	0.35	NS	NS
SFA 5.17 (EM12K)	0.05-0.15	0.10-0.35	0.030 MAX	0.030 MAX	0.80-1.25	NS	NS	NS	NS	0.35	NS	NS

NS = NOT SPECIFIED

ALL ANALYSIS IS OPTICAL EMISSION SPECTROSCOPY EXCEPT THE CARBON WHICH IS LECO

NO ALLOYS OR WELD WIRE GRADES WERE SPECIFIED SO TYPICAL ARE PRESENTED

* TOTAL OF MN+NI+CR+MO+V 1.75 MAX

SA-515 SPECIFICATION FOR PRESSURE VESSEL PLATES, CARBON STEEL, FOR INTERMEDIATE-AND HIGHER-TEMPERATURE SERVICE – JULY 2003 ADDENDUM

SFA 5.1 SPECIFICATION FOR CARBON STEEL ELECTRODES FOR SHIELD METAL ARC WELDING-JULY 2003 ADDENDUM

SFA 5.17 SPECIFICATION FOR CARBON STEEL ELECTRODES AND FLUXES FOR SUBMERGED ARC WELDING- JULY 2003 ADDENDUM

BETA LAB No. M10198, TESORO LS2 AND LS2/CS2 TEE FINDINGS
PART: 6600-E HEAT EXCHANGER, LS2 22 IN, 36.5 IN MOUNTS, LS2 T2L SEM FRACTOGRAPHY AND PART 22 LS2-CS2 TEE FINDINGS PARTS 16-1 AND 22

TESORO REFINING AND MARKETING COMPANY
 ANACORTES REFINERY
 10200 W. MARCH POINT ROAD T91WA4428
 ANACORTES, WA 98221

CUSTOMER P.O. No.: 4501667904

DATE: OCTOBER 13, 2010

PAGE 7 OF 56

LABORATORY REPORT

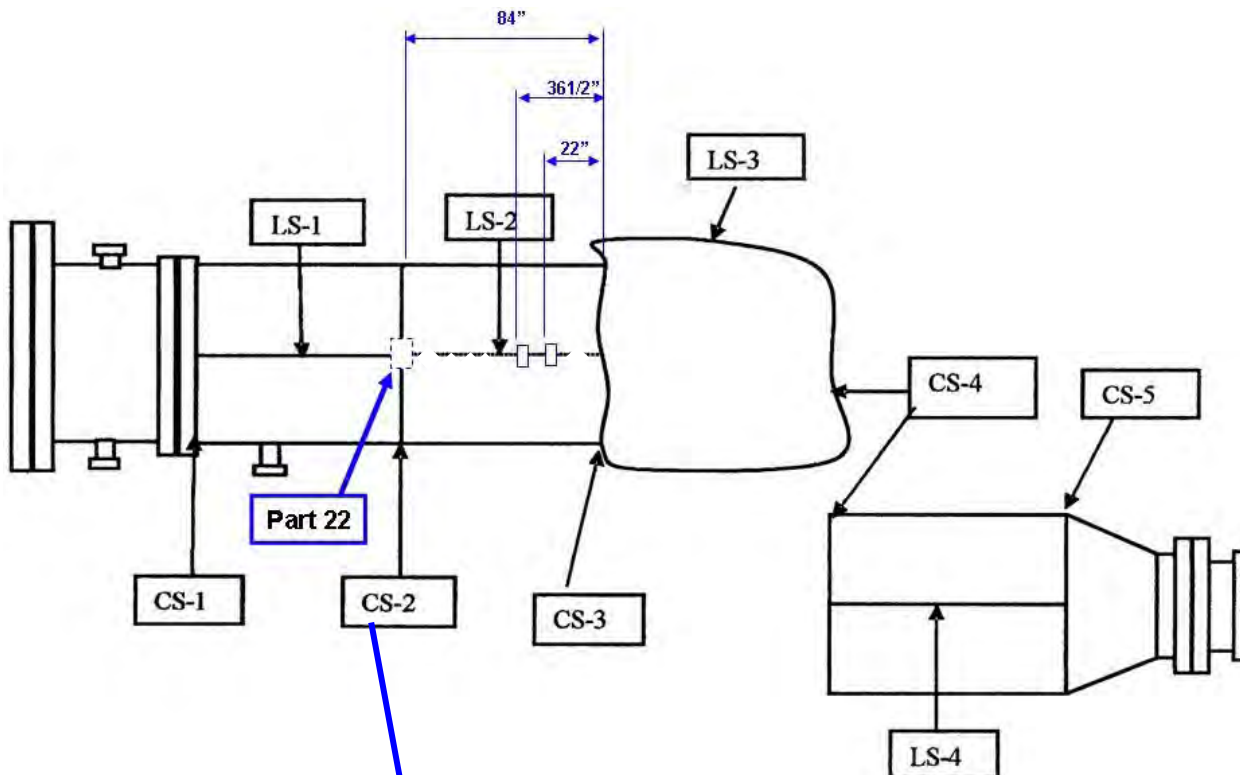

Sketch of main heat exchanger Cars 1-3 and separated back head can 4. Marked samples at 22", 36 1/2", and Part 22 from which two samples were cut (see Figures 22 and 23)

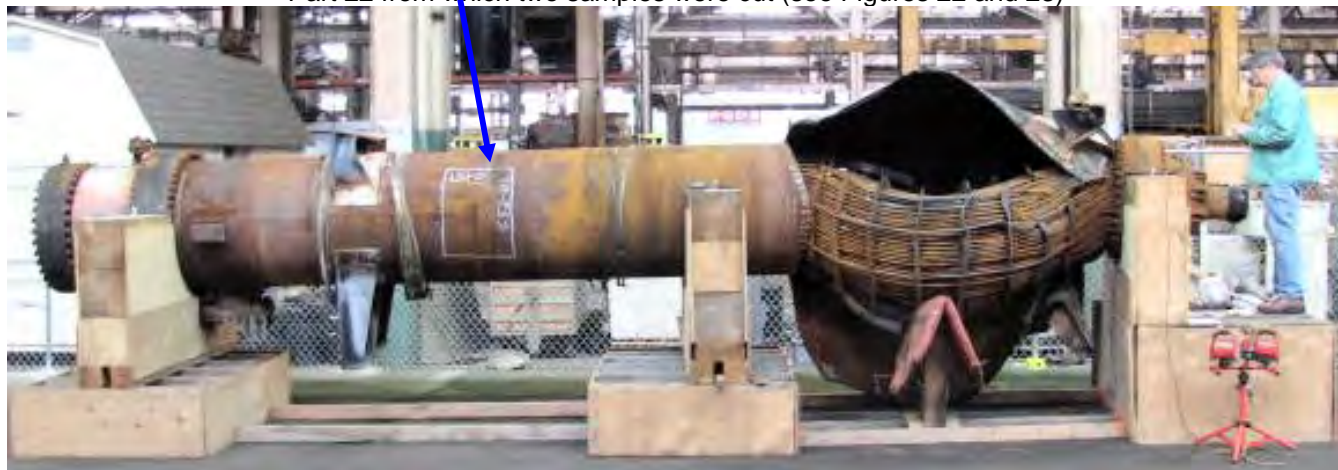

Overall main heat exchanger with "fish mouth" rupture primarily along LS3 and CS4

Figure 1 Un-packed main heat exchanger

BETA LAB NO. M10198, TESORO LS2 AND LS2/CS2 TEE FINDINGS PART: 6600-E HEAT EXCHANGER, LS2 22 IN, 36.5 IN MOUNTS, LS2 T2L SEM FRACTOGRAPHY AND PART 22 LS2-CS2 TEE FINDINGS PARTS 16-1 AND 22	TESORO REFINING AND MARKETING COMPANY ANACORTES REFINERY 10200 W. MARCH POINT ROAD T91WA4428 ANACORTES, WA 98221	CUSTOMER P.O. No.: 4501667904
		DATE: OCTOBER 13, 2010
		PAGE 8 OF 56

LABORATORY REPORT

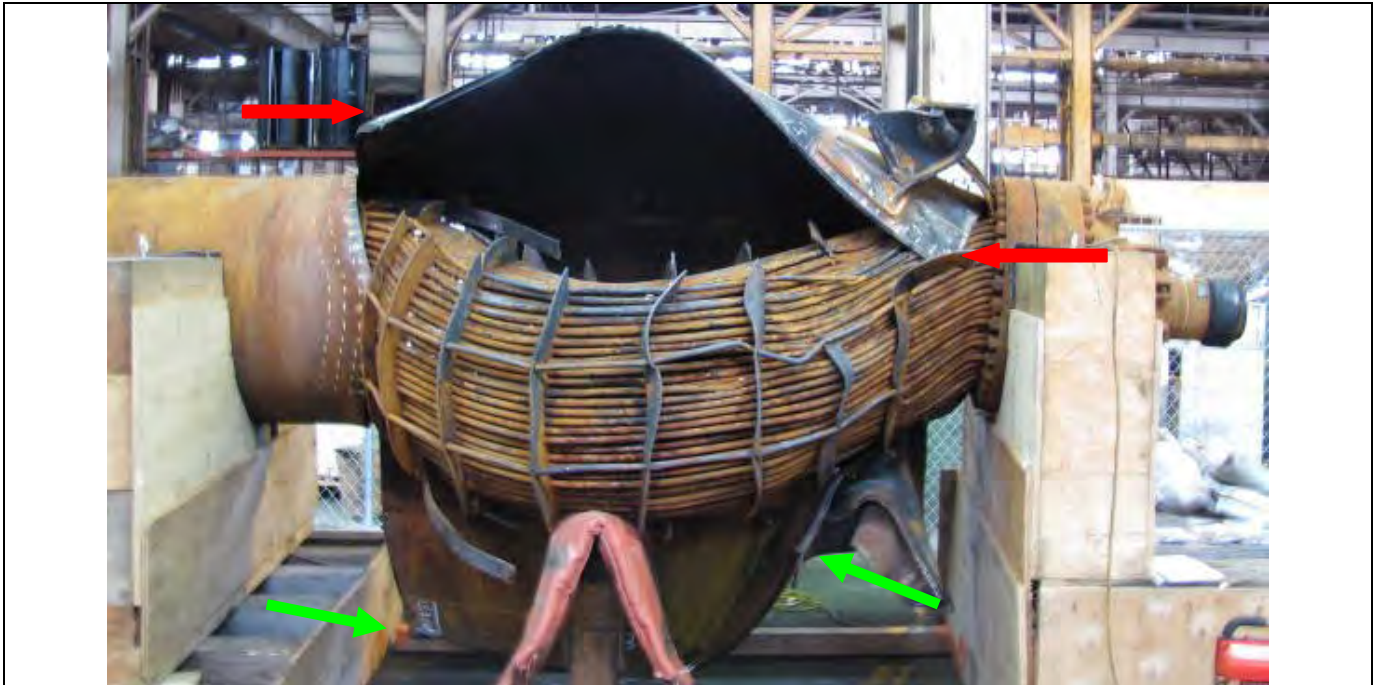

Fracture along LS3 seam between the green arrows for the bottom part of the fracture, and for the LS3 top – between the red arrows

Figure 2 Photo showing the fracture along LS3 where an approximate 6 inch wide portion was removed

BETA LAB No. M10198, TESORO LS2 AND LS2/CS2 TEE FINDINGS PART: 6600-E HEAT EXCHANGER, LS2 22 IN, 36.5 IN MOUNTS, LS2 T2L SEM FRACTOGRAPHY AND PART 22 LS2-CS2 TEE FINDINGS PARTS 16-1 AND 22	TESORO REFINING AND MARKETING COMPANY ANACORTES REFINERY 10200 W. MARCH POINT ROAD T91WA4428 ANACORTES, WA 98221	CUSTOMER P.O. No.: 4501667904
		DATE: OCTOBER 13, 2010
		PAGE 9 OF 56

LABORATORY REPORT

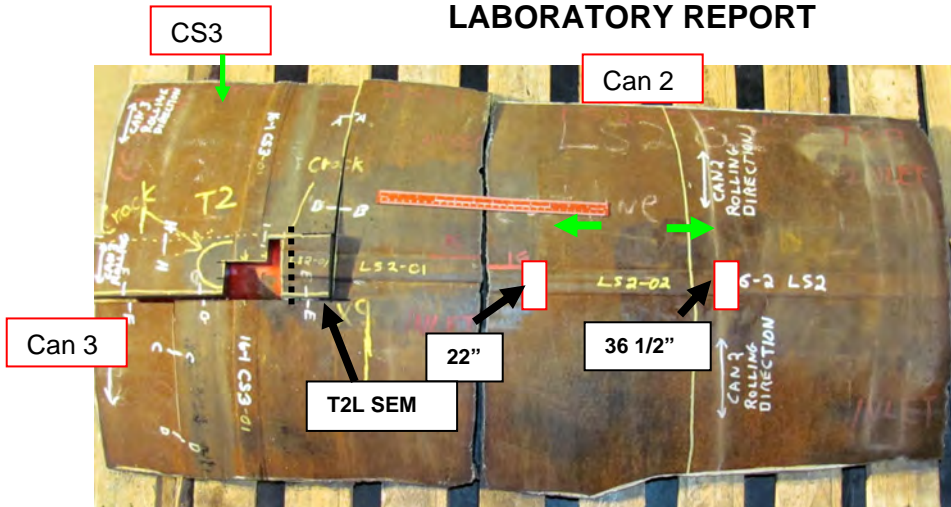

Part 16-1 with locations for the 22 inch, 36.5 inch mounts, and the part the T2L SEM was cut out (black dotted line).

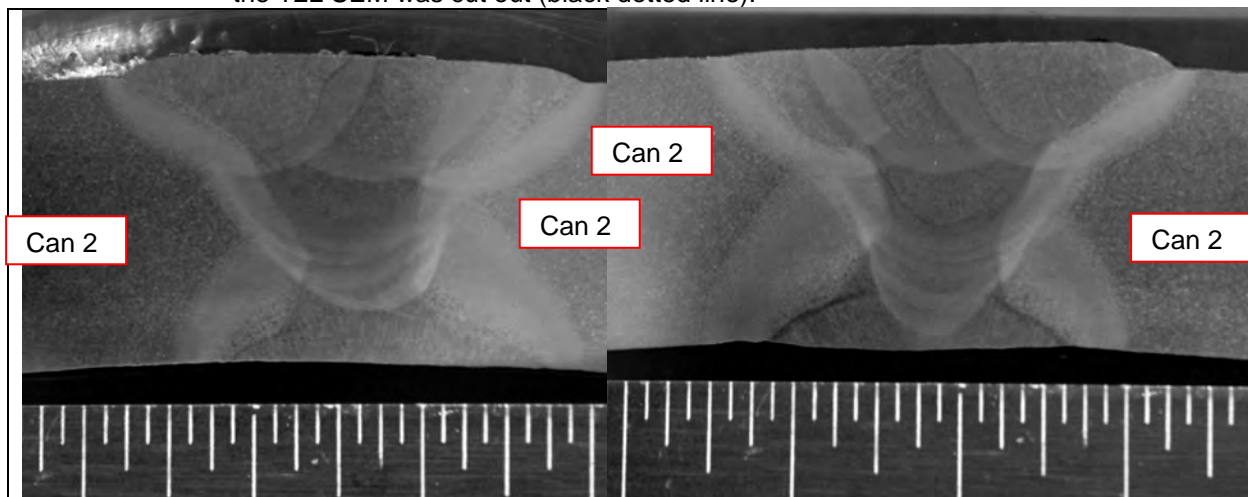

Photomicrograph of 22 inch sample-ID on bottom, scale mark is 1/16 inch

Photomicrograph of 36.5 inch sample-ID on bottom, scale mark is 1/16 inch

FIGURE 4 Photomicrographs of the mounts for 22 and 36.5 inch along LS2 – ID on the bottom of each mount

BETA LAB No.M10198, TESORO LS2 AND LS2/CS2 TEE FINDINGS	TESORO REFINING AND MARKETING COMPANY ANACORTES REFINERY 10200 W. MARCH POINT ROAD T91WA4428 ANACORTES, WA 98221	CUSTOMER P.O. No.: 4501667904
PART: 6600-E HEAT EXCHANGER, LS2 22 IN, 36.5 IN MOUNTS, LS2 T2L SEM FRACTOGRAPHY AND PART 22 LS2-CS2 TEE FINDINGS PARTS 16-1 AND 22		DATE: OCTOBER 13, 2010
		PAGE 10 OF 56

LABORATORY REPORT

**22 INCH SAMPLE
FROM
LS2 WELD**

BETA LAB NO. M10198, TESORO LS2 AND LS2/CS2 TEE FINDINGS
PART: 6600-E HEAT EXCHANGER, LS2 22 IN, 36.5 IN MOUNTS, LS2 T2L SEM FRACTOGRAPHY AND PART 221 LS2-CS2 TEE FINDINGS PARTS 16-1 AND 22

TESORO REFINING AND MARKETING COMPANY
ANACORTES REFINERY
10200 W. MARCH POINT ROAD T91WA4428
ANACORTES, WA 98221

CUSTOMER P.O. No.: 4501667904

DATE: OCTOBER 13, 2010

PAGE 11 OF 56

LABORATORY REPORT

LS2 22" SAMPLE

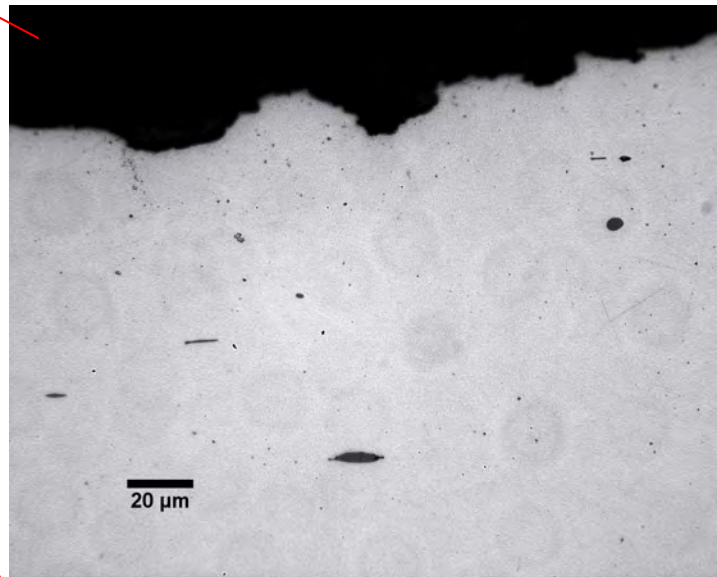
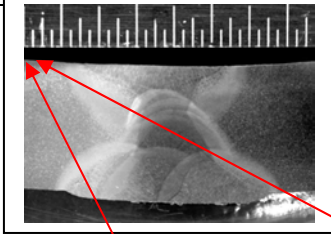

A. Base metal. Un-etched

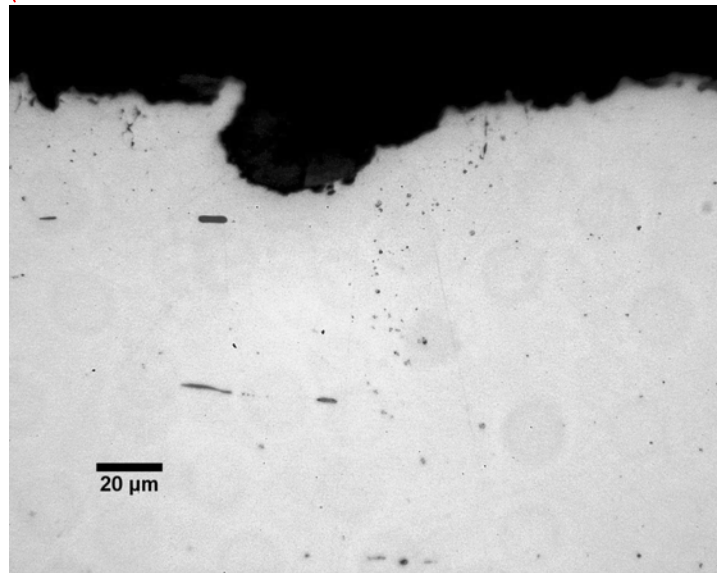

B. Base metal. Un-etched

Figure 5

BETA LAB NO. M10198, TESORO LS2 AND LS2/CS2 TEE FINDINGS PART: 6600-E HEAT EXCHANGER, LS2 22 IN, 36.5 IN MOUNTS, LS2 T2L SEM FRACTOGRAPHY AND PART 221 LS2-CS2 TEE FINDINGS PARTS 16-1 AND 22	TESORO REFINING AND MARKETING COMPANY ANACORTES REFINERY 10200 W. MARCH POINT ROAD T91WA4428 ANACORTES, WA 98221	CUSTOMER P.O. No.: 4501667904
		DATE: OCTOBER 13, 2010
		PAGE 12 OF 56

LABORATORY REPORT

LS2 22" SAMPLE

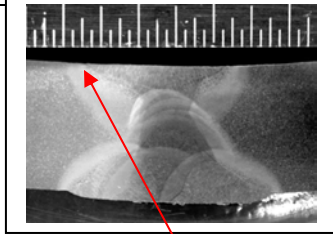

SEE FIGURE 7A&B

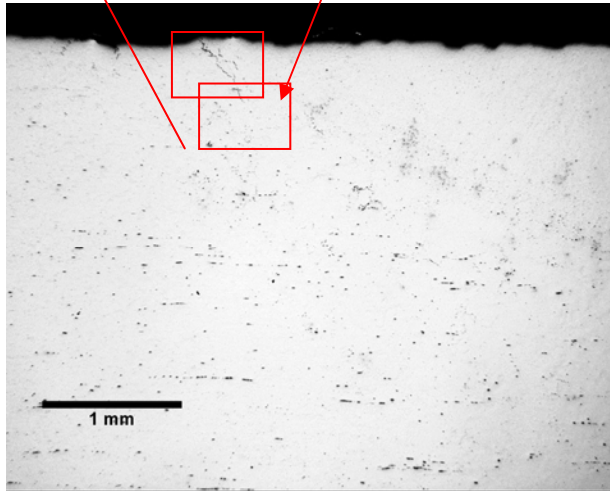

A. Toe of the weld. Un-etched

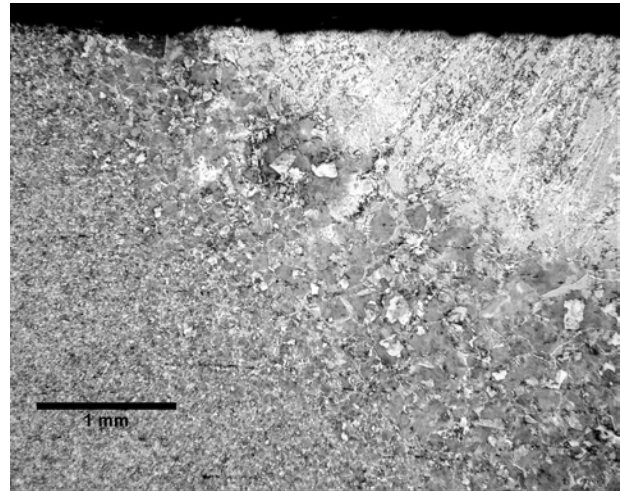

B. Same as at left. Etched

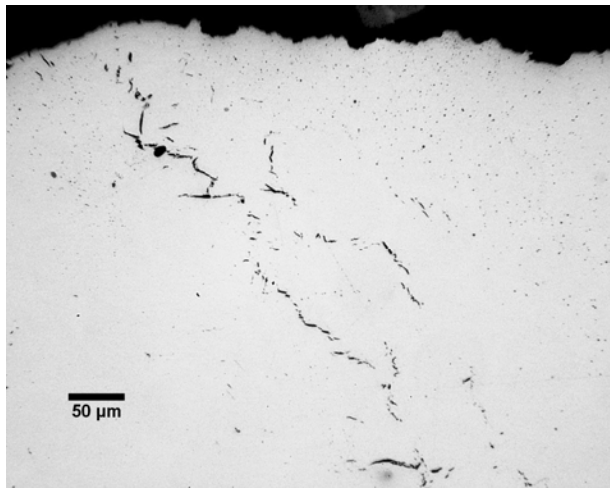

C. Enlarged area from [A] above. Un-etched

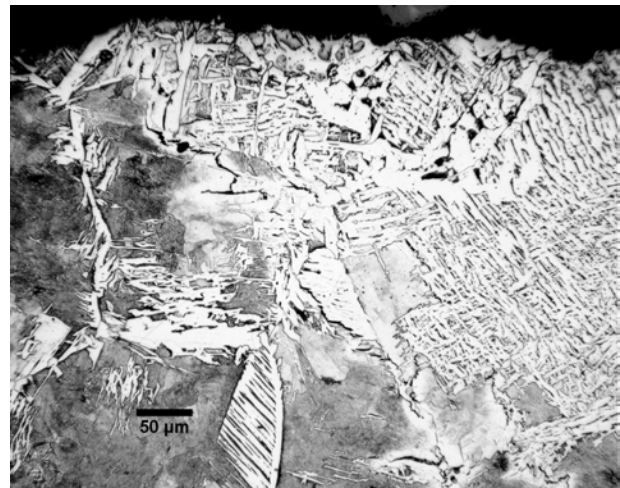

D. Same as at left. Etched

Figure 6

BETA LAB NO. M10198, TESORO LS2 AND LS2/CS2 TEE FINDINGS PART: 6600-E HEAT EXCHANGER, LS2 22 IN, 36.5 IN MOUNTS, LS2 T2L SEM FRACTOGRAPHY AND PART 22 LS2-CS2 TEE FINDINGS PARTS 16-1 AND 22	TESORO REFINING AND MARKETING COMPANY ANACORTES REFINERY 10200 W. MARCH POINT ROAD T91WA4428 ANACORTES, WA 98221	CUSTOMER P.O. No.: 4501667904
		DATE: OCTOBER 13, 2010
		PAGE 13 OF 56

LABORATORY REPORT
LS2 22" SAMPLE

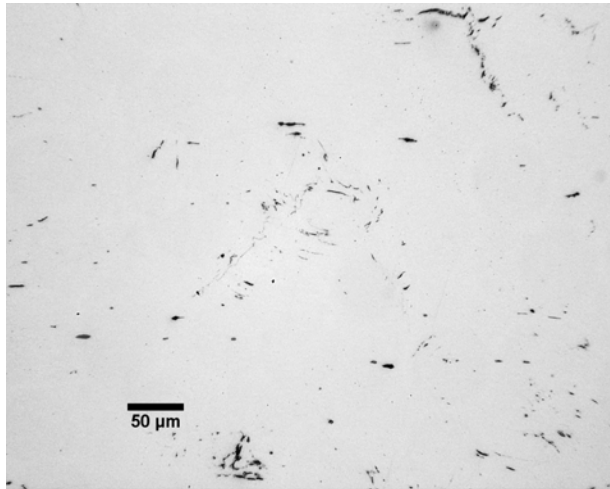

A. Area from Fig. 6A. Un-etched

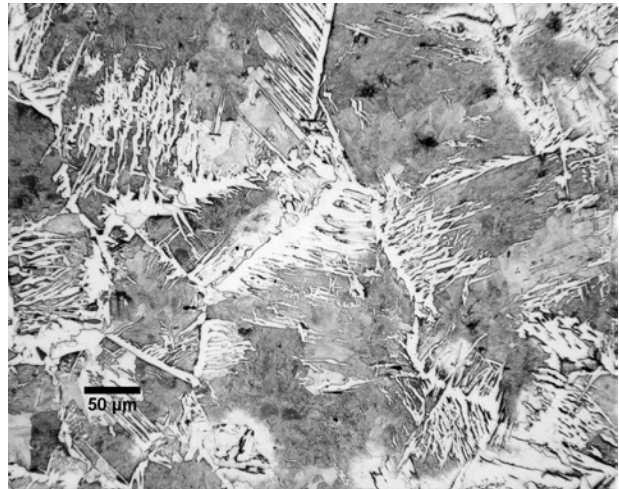

B. Same as at left. Etched

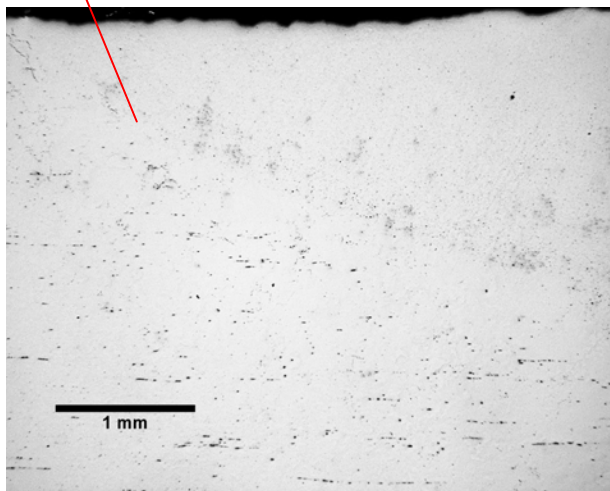
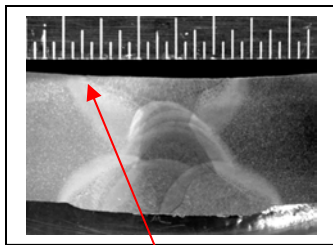

C. Area at the weld toe. Un-etched

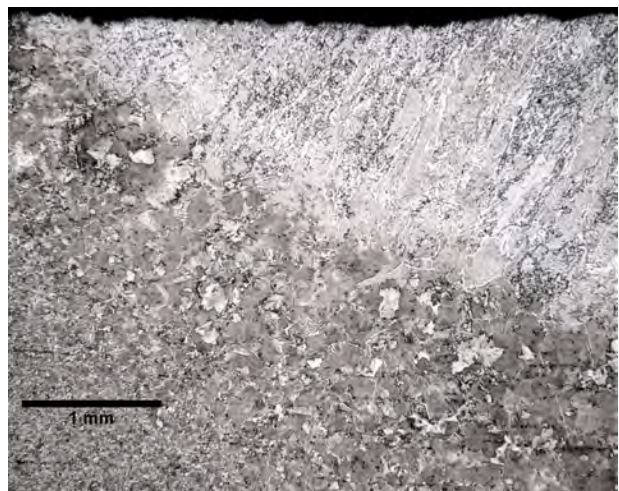

D. Same as at left. Etched

Figure 7

BETA LAB NO. M10198, TESORO LS2 AND LS2/CS2 TEE FINDINGS PART: 6600-E HEAT EXCHANGER, LS2 22 IN, 36.5 IN MOUNTS, LS2 T2L SEM FRACTOGRAPHY AND PART 22 LS2-CS2 TEE FINDINGS PARTS 16-1 AND 22	TESORO REFINING AND MARKETING COMPANY ANACORTES REFINERY 10200 W. MARCH POINT ROAD T91WA4428 ANACORTES, WA 98221	CUSTOMER P.O. No.: 4501667904
		DATE: OCTOBER 13, 2010
		PAGE 14 OF 56

LABORATORY REPORT

LS2 22" SAMPLE

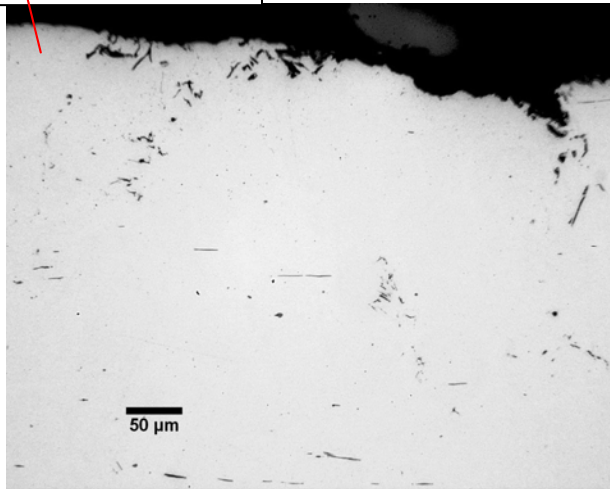
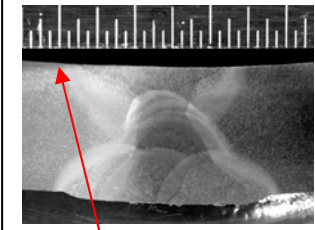

A. Area at the toe farther from the weld. Un-etched

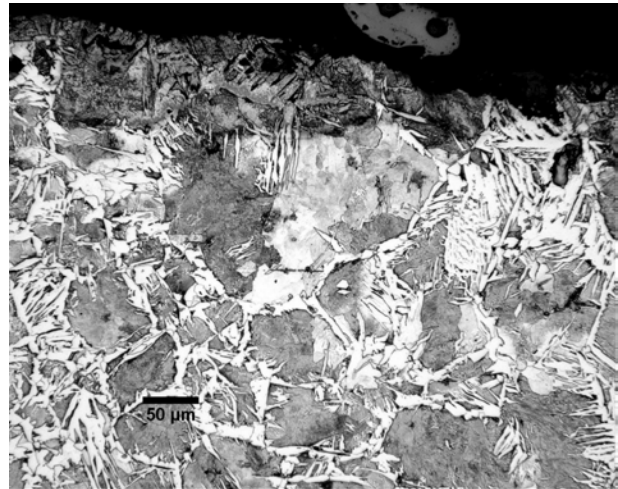

B. Same as at left. Etched

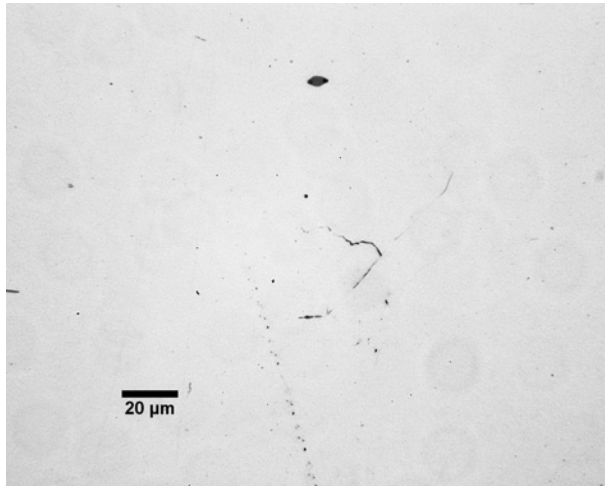

C. Area at the toe farther from the weld one field down from the ID. Un-etched

Figure 8

BETA LAB NO. M10198, TESORO LS2 AND LS2/CS2
 TEE FINDINGS
 PART: 6600-E HEAT EXCHANGER, LS2 22 IN, 36.5 IN
 MOUNTING LEGS, SEMI-TOPOGRAPHY AND PART
 6-1 AND 22

TESORO REFINING AND MARKETING COMPANY
 ANACORTES REFINERY
 10200 W. MARCH POINT ROAD T91WA4428
 ANACORTES, WA 98221

CUSTOMER P.O. No.: 4501667904

DATE: OCTOBER 13, 2010

PAGE 15 OF 56

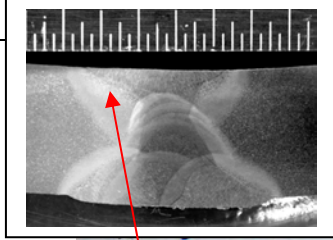

LABORATORY REPORT
LS2 22" SAMPLE

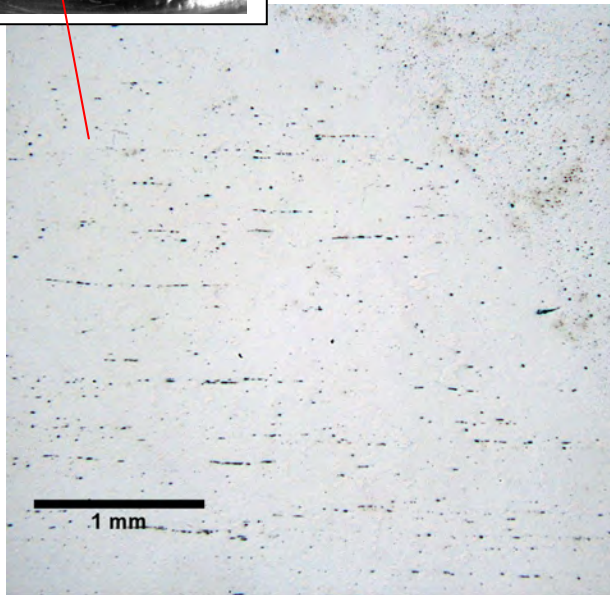

A. Area along the fusion line down from the ID. Un-etched

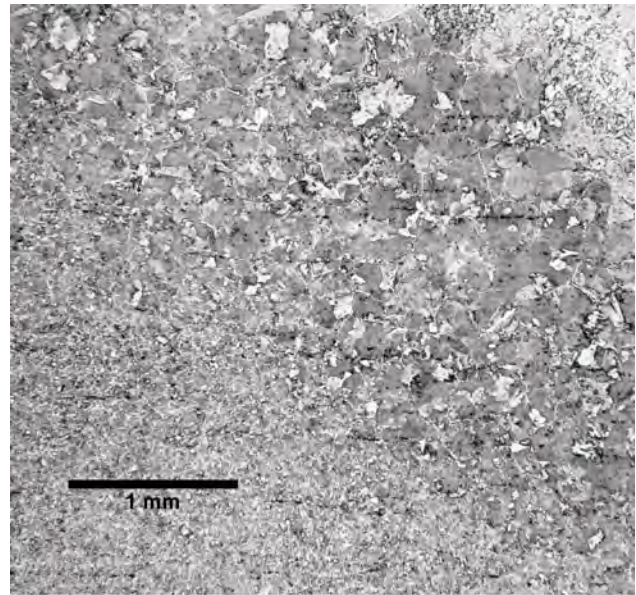

B. Same as at left. Etched

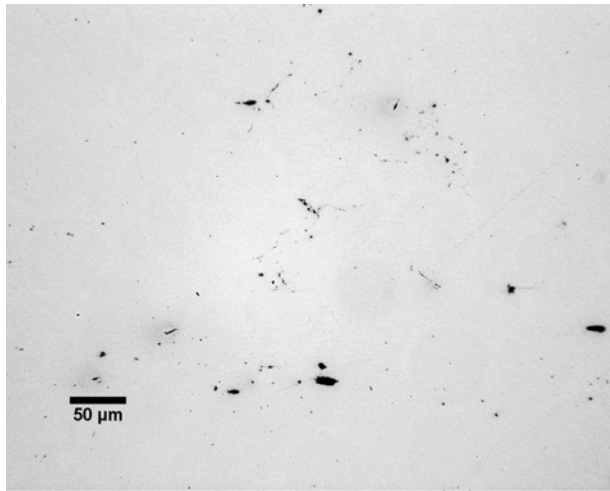

C. Enlarged area from the [A] above. Un-etched

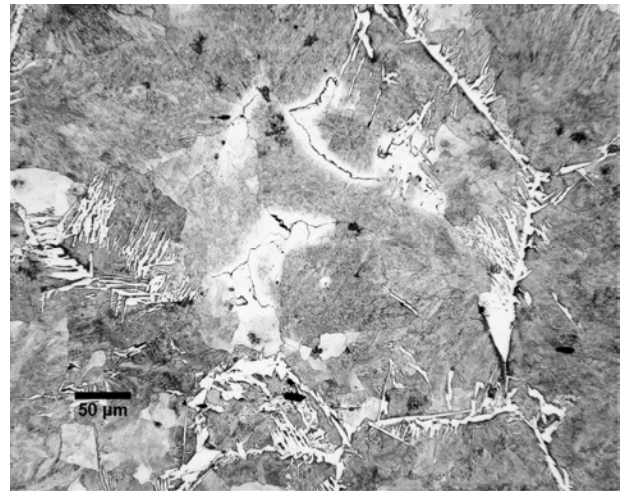

D. Same as at left. Etched

Figure 9

BETA LAB NO. M10198, TESORO LS2 AND LS2/CS2 TEE FINDINGS PART: 6600-E HEAT EXCHANGER, LS2 22 IN, 36.5 IN MOUNTS, LS2 T2L SEM FRACTOGRAPHY AND PART 221 LS2-CS2 TEE FINDINGS PARTS 16-1 AND 22	TESORO REFINING AND MARKETING COMPANY ANACORTES REFINERY 10200 W. MARCH POINT ROAD T91WA4428 ANACORTES, WA 98221	CUSTOMER P.O. No.: 4501667904
		DATE: OCTOBER 13, 2010
		PAGE 16 OF 56

LABORATORY REPORT

LS2 22" SAMPLE

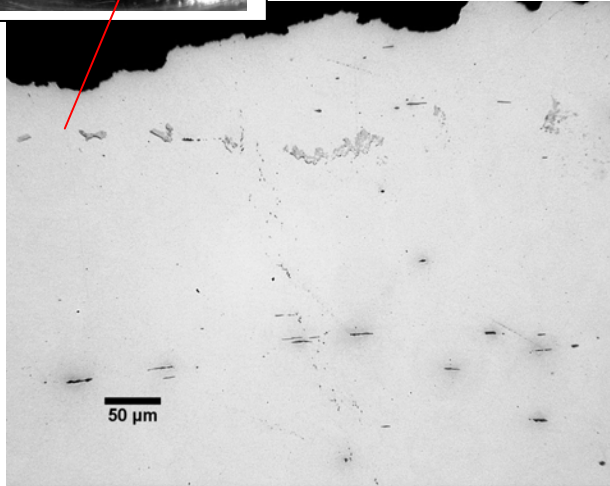
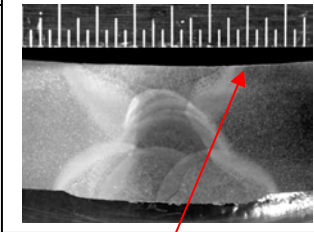

A. HAZ - Base metal, right of the weld near the ID.
 Un-etched

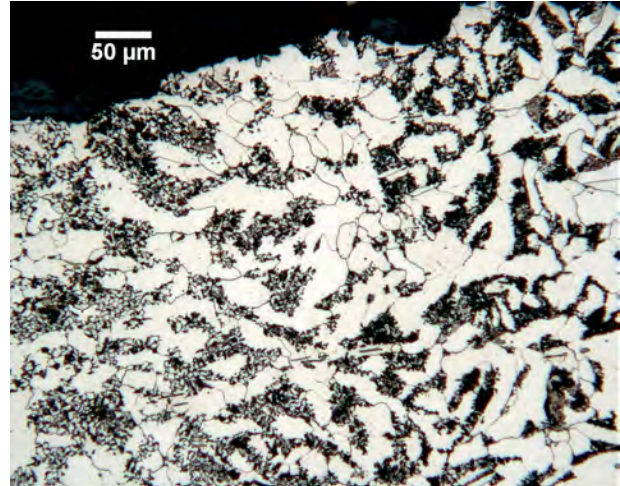

B. Same as at left. Etched

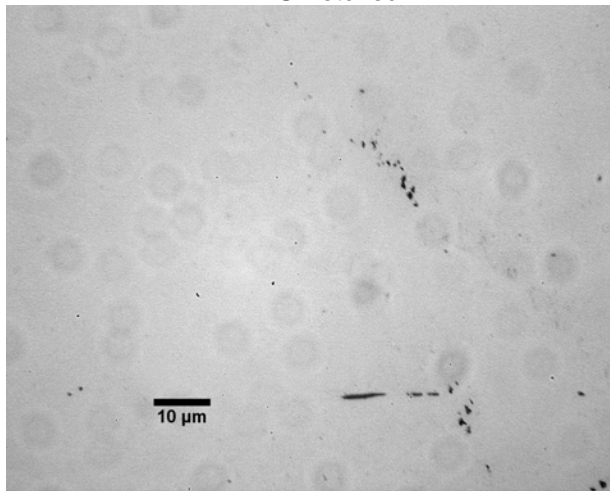

C. Enlarged area of the base metal from the [A] above. Un-etched

Figure 10

BETA LAB NO. M10198, TESORO LS2 AND LS2/CS2 TEE FINDINGS PART: 6600-E HEAT EXCHANGER, LS2 22 IN, 36.5 IN MOUNTS, LS2 T2L SEM FRACTOGRAPHY AND PART 22 LS2-CS2 TEE FINDINGS PARTS 16-1 AND 22	TESORO REFINING AND MARKETING COMPANY ANACORTES REFINERY 10200 W. MARCH POINT ROAD T91WA4428 ANACORTES, WA 98221	CUSTOMER P.O. No.: 4501667904
		DATE: OCTOBER 13, 2010
		PAGE 17 OF 56

LABORATORY REPORT

LS2 22" SAMPLE

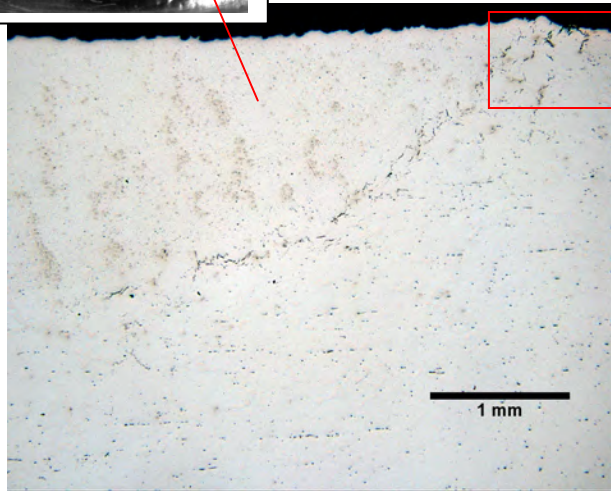
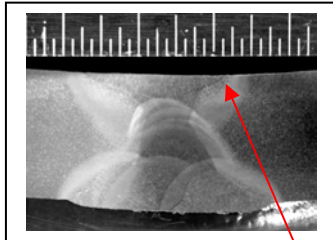

A. Toe of the weld. Un-etched

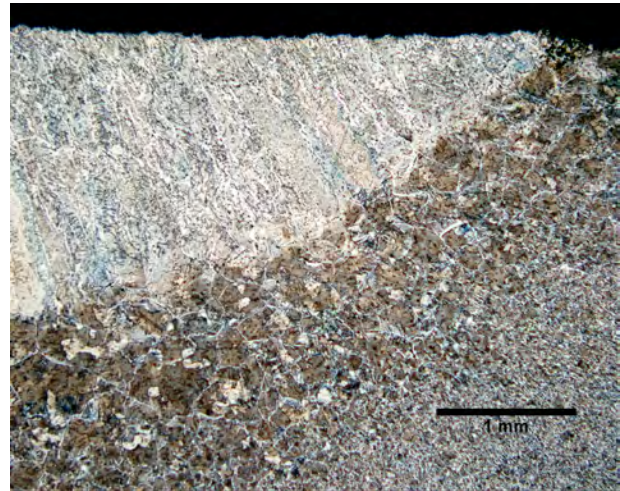

B. Same as at left. Etched

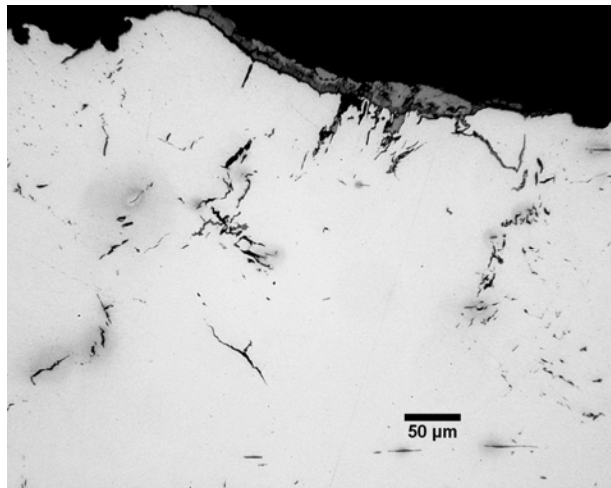

C. Enlarged area marked in [A] above Un-etched

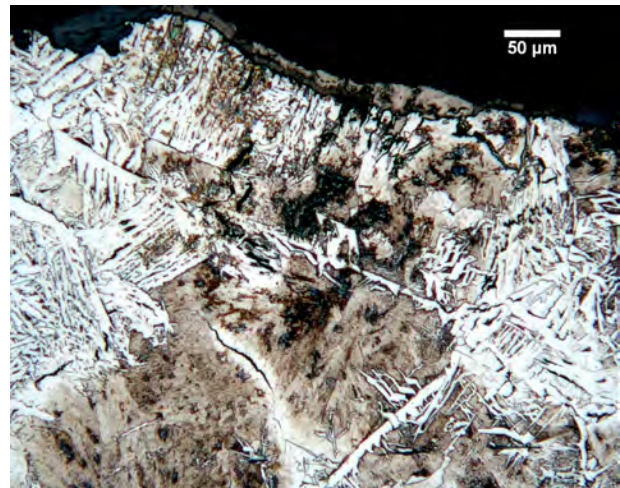

D. Same as at left. Etched

Figure 11

BETA LAB NO. M10198, TESORO LS2 AND LS2/CS2 TEE FINDINGS
 PART: 6600-E HEAT EXCHANGER, LS2 22 IN, 36.5 IN MOUNTS, LS2 T2L SEM FRACTOGRAPHY AND PART 22 LS2-CS2 TEE FINDINGS PARTS 16-1 AND 22

TESORO REFINING AND MARKETING COMPANY
 ANACORTES REFINERY
 10200 W. MARCH POINT ROAD T91WA4428
 ANACORTES, WA 98221

CUSTOMER P.O. No.: 4501667904

DATE: OCTOBER 13, 2010

PAGE 18 OF 56

LABORATORY REPORT

LS2 22" SAMPLE

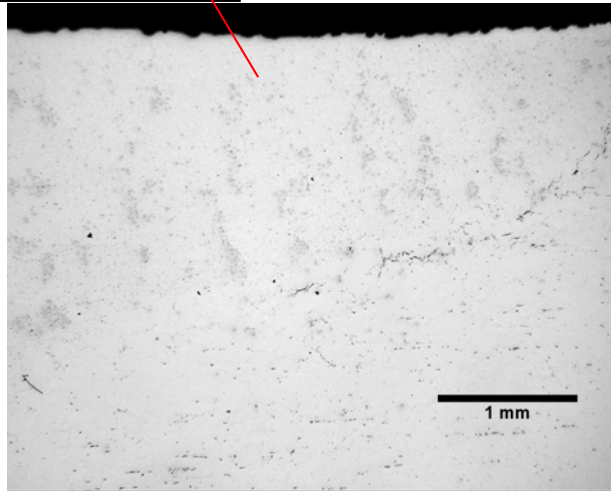
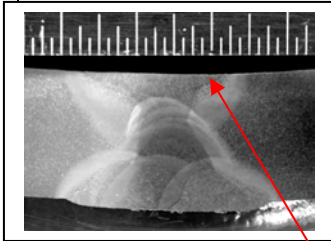

A. Area at the toe toward the weld. Un-etched

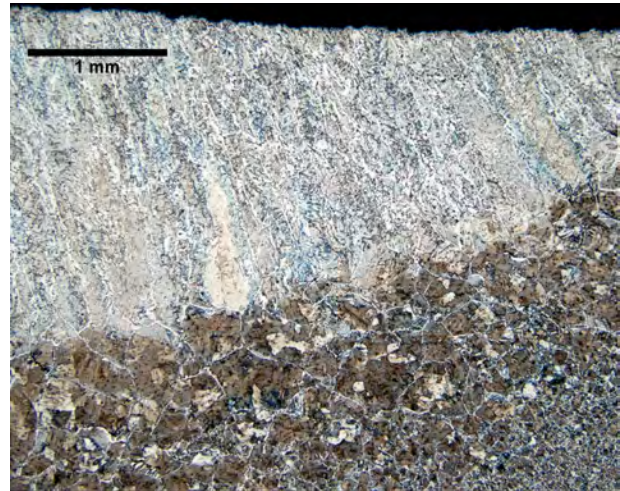

B. Same as at left. Etched

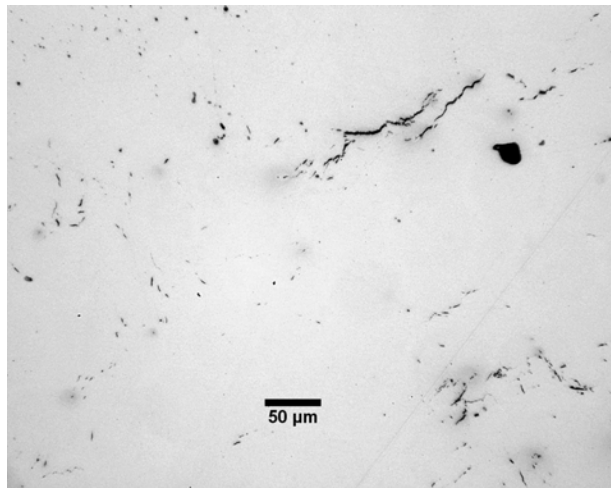

C. Enlarged area at the fusion line. Un-etched

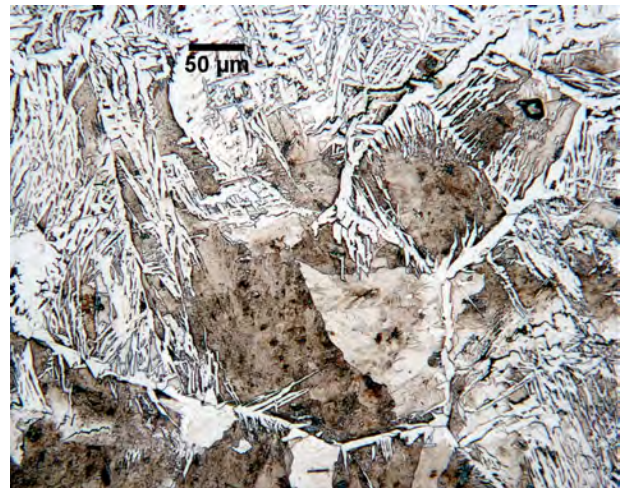

D. Same as at left. Etched

Figure 12

BETA LAB NO. M10198, TESORO LS2 AND LS2/CS2 TEE FINDINGS PART: 6600-E HEAT EXCHANGER, LS2 22 IN, 36.5 IN MOUNTS, LS2 T2L SEM FRACTOGRAPHY AND PART 221 LS2-CS2 TEE FINDINGS PARTS 16-1 AND 22	TESORO REFINING AND MARKETING COMPANY ANACORTES REFINERY 10200 W. MARCH POINT ROAD T91WA4428 ANACORTES, WA 98221	CUSTOMER P.O. No.: 4501667904
		DATE: OCTOBER 13, 2010
		PAGE 19 OF 56

LABORATORY REPORT

LS2 22" SAMPLE

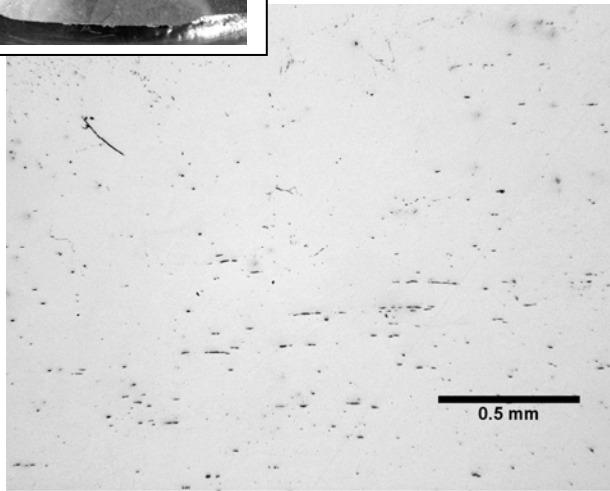
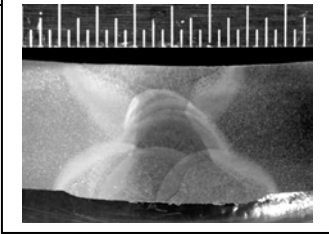

A. HAZ area down from the ID. Un-etched

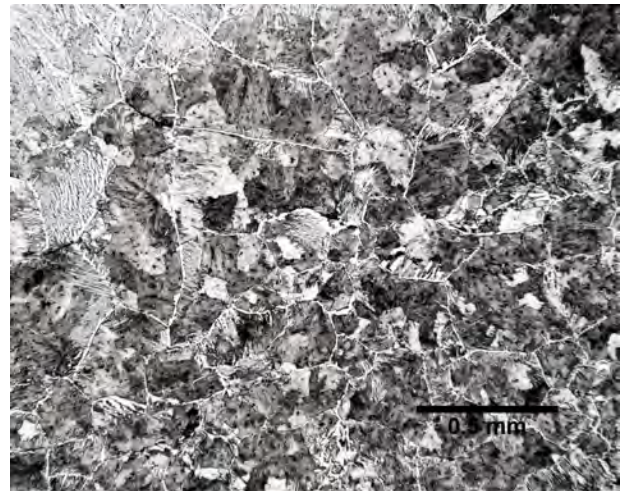

B. Same as at left. Etched

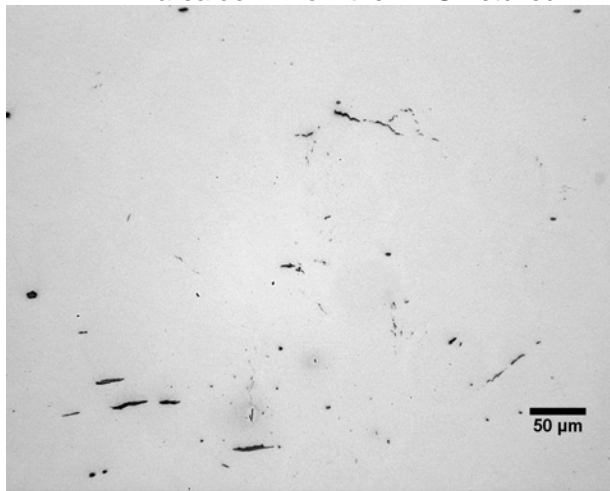

C. Enlarged area from [A] above. Un-etched

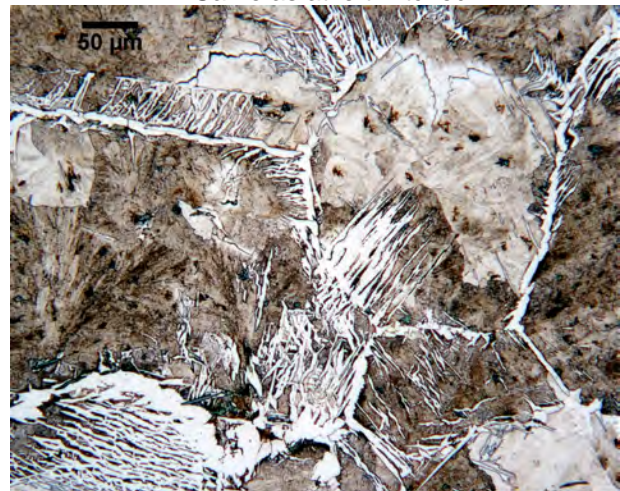

D. Same as at left. Etched

Figure 13

BETA LAB No.M10198, TESORO LS2 AND LS2/CS2 TEE FINDINGS	TESORO REFINING AND MARKETING COMPANY ANACORTES REFINERY 10200 W. MARCH POINT ROAD T91WA4428 ANACORTES, WA 98221	CUSTOMER P.O. No.: 4501667904
PART: 6600-E HEAT EXCHANGER, LS2 22 IN, 36.5 IN MOUNTS, LS2 T2L SEM FRACTOGRAPHY AND PART 22 LS2-CS2 TEE FINDINGS PARTS 16-1 AND 22		DATE: OCTOBER 13, 2010
		PAGE 20 OF 56

LABORATORY REPORT

36 1/2 INCH SAMPLE
FROM
LS2 WELD

BETA LAB NO. M10198, TESORO LS2 AND LS2/CS2 TEE FINDINGS PART: 6600-E HEAT EXCHANGER, LS2 22 IN, 36.5 IN MOUNTS, LS2 T2L SEM FRACTOGRAPHY AND PART 2 AND 22	TESORO REFINING AND MARKETING COMPANY ANACORTES REFINERY 10200 W. MARCH POINT ROAD T91WA4428 ANACORTES, WA 98221	CUSTOMER P.O. No.: 4501667904
		DATE: OCTOBER 13, 2010
		PAGE 21 OF 56

LABORATORY REPORT
LS2 36 1/2" SAMPLE

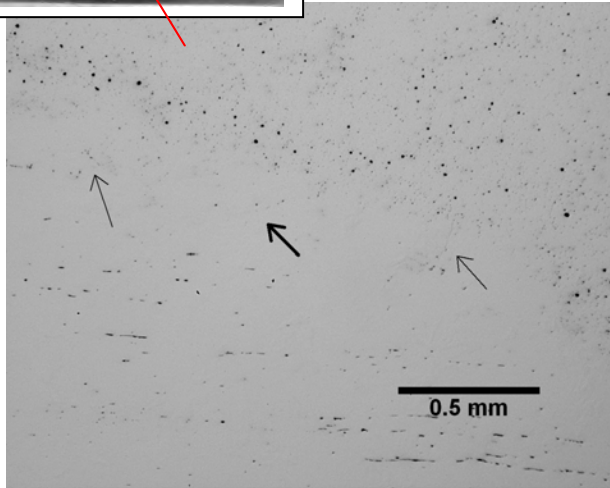
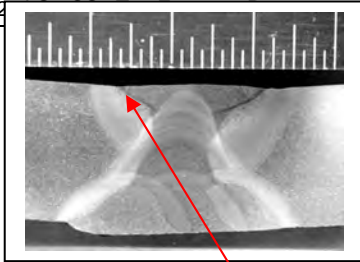

A. HAZ-Weld metal interface 3.28 mm down from ID. Un-etched

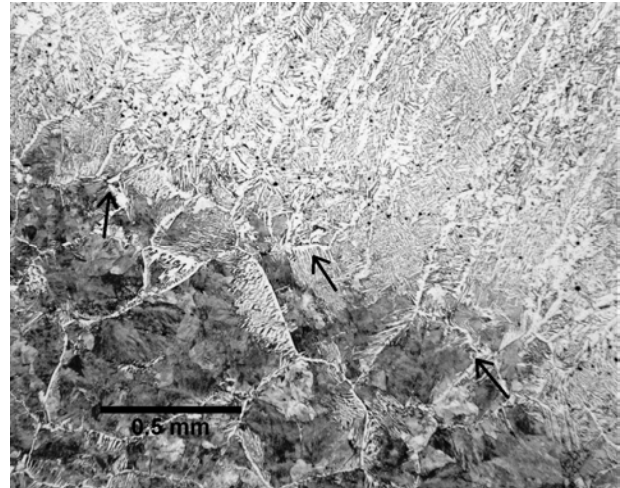

B. Same as at left. Etched

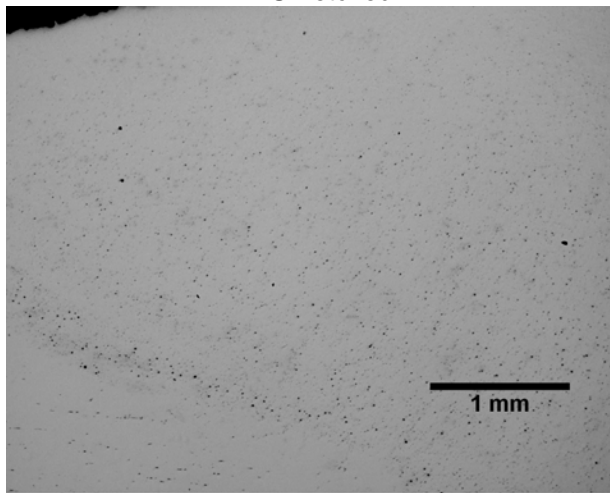

C. Same 3.28 mm level, different area. Un-etched

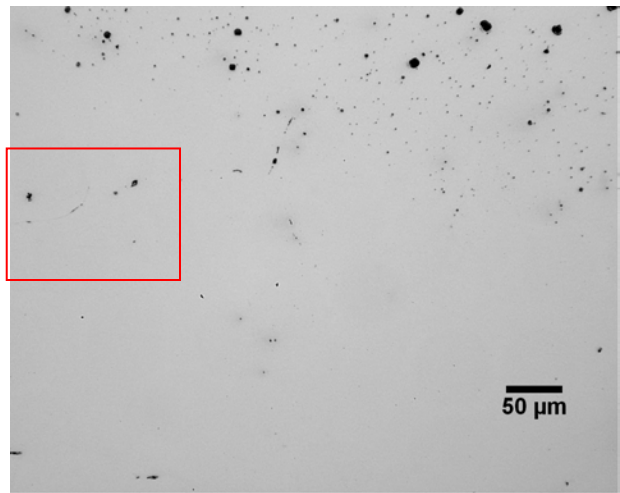

D. Same area as at left, enlarged. See marked area on Figure 15A below. Un-etched

Figure 14

BETA LAB No. M10198, TESORO LS2 AND LS2/CS2 TEE FINDINGS
 PART: 6600-E HEAT EXCHANGER, LS2 22 IN, 36.5 IN MOUNTS, LS2 T2L SEM FRACTOGRAPHY AND PART 22 LS2-CS2 TEE FINDINGS PARTS 16-1 AND 22

TESORO REFINING AND MARKETING COMPANY
 ANACORTES REFINERY
 10200 W. MARCH POINT ROAD T91WA4428
 ANACORTES, WA 98221

CUSTOMER P.O. No.: 4501667904

DATE: OCTOBER 13, 2010

PAGE 22 OF 56

LABORATORY REPORT

LS2 36 1/2" SAMPLE

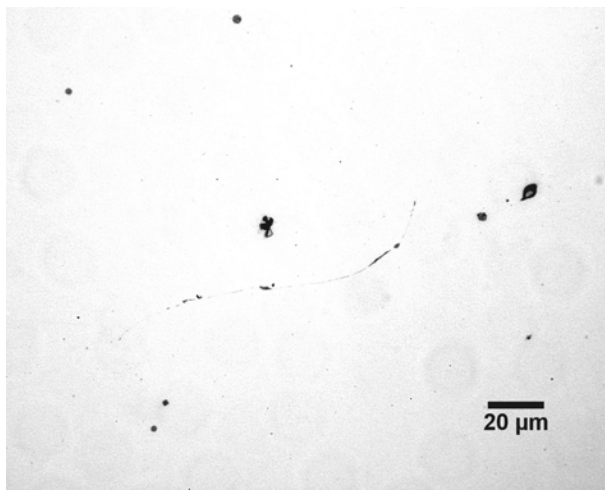
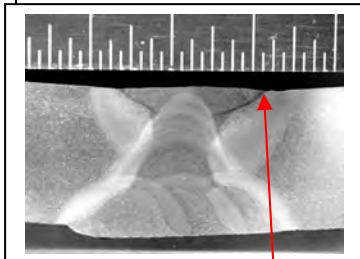

A. Enlarged area from Figure 14D above. Un-etched

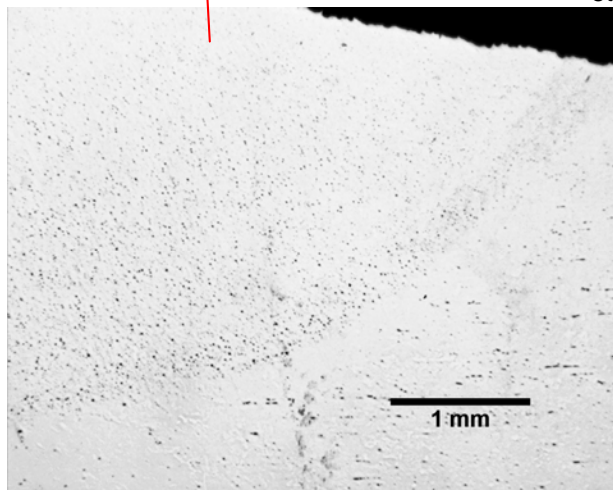

B. Weld metal-HAZ at ID. Un-etched

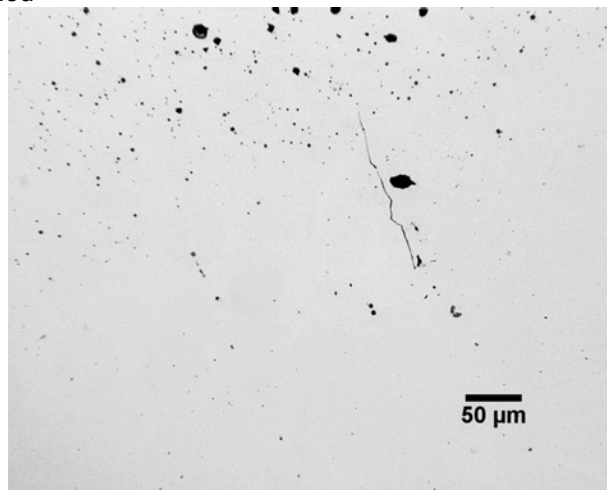

C. Same as at left, enlarged. Un-etched

Figure 15

BETA LAB NO. M10198, TESORO LS2 AND LS2/CS2 TEE FINDINGS PART: 6600-E HEAT EXCHANGER, LS2 22 IN, 36.5 IN MOUNTS, LS2 T2L SEM FRACTOGRAPHY AND PART 22 LS2-CS2 TEE FINDINGS PARTS 16-1 AND 22	TESORO REFINING AND MARKETING COMPANY ANACORTES REFINERY 10200 W. MARCH POINT ROAD T91WA4428 ANACORTES, WA 98221	CUSTOMER P.O. No.: 4501667904
		DATE: OCTOBER 13, 2010
		PAGE 23 OF 56

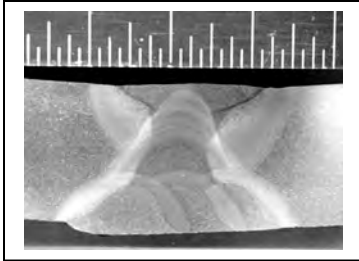

**LABORATORY REPORT
LS2 36 1/2" SAMPLE**

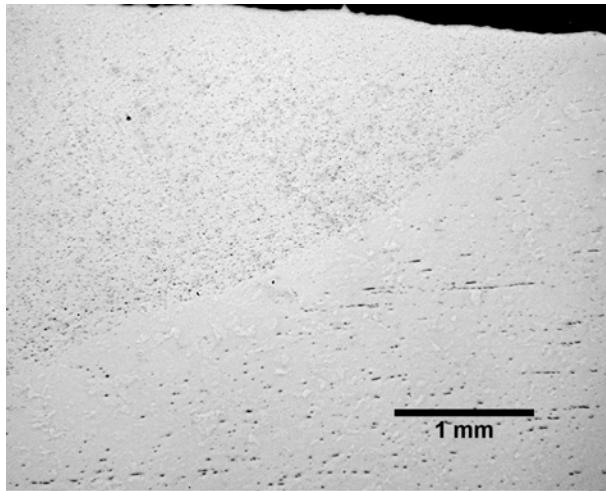

A. Area 1.97 mm down from ID at the Weld-HAZ interface. Un-etched

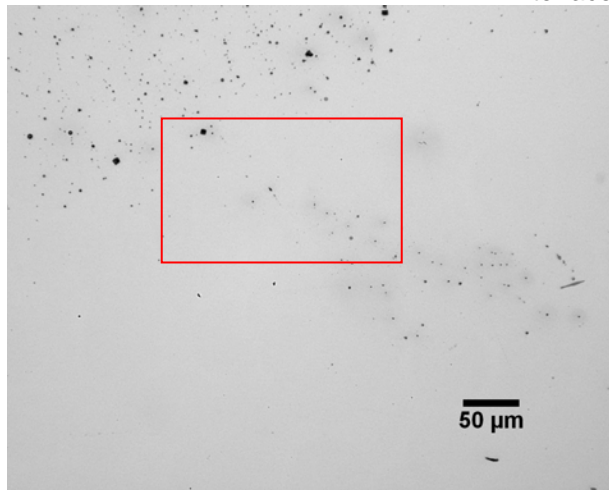

B. Same as in [A] above, enlarged. Un-etched

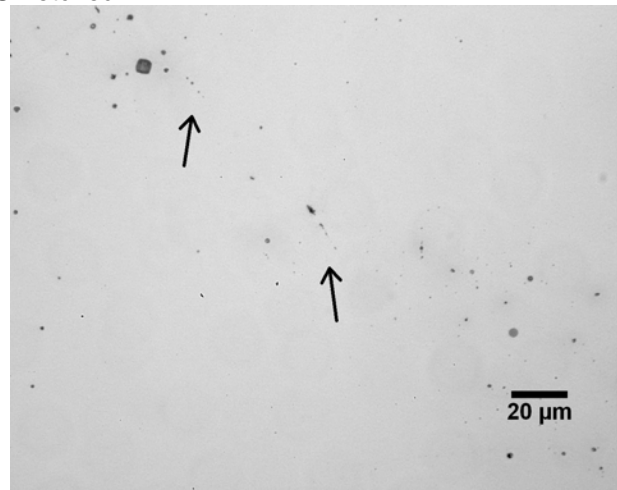

C. Enlarged area marked on [B] at left. Un-etched

Figure 16

BETA LAB No.M10198, TESORO LS2 AND LS2/CS2 TEE FINDINGS	TESORO REFINING AND MARKETING COMPANY ANACORTES REFINERY 10200 W. MARCH POINT ROAD T91WA4428 ANACORTES, WA 98221	CUSTOMER P.O. No.: 4501667904
PART: 6600-E HEAT EXCHANGER, LS2 22 IN, 36.5 IN MOUNTS, LS2 T2L SEM FRACTOGRAPHY AND PART 22 LS2-CS2 TEE FINDINGS PARTS 16-1 AND 22		DATE: OCTOBER 13, 2010
		PAGE 24 OF 56

LABORATORY REPORT

T2L SEM SAMPLE FROM LS2 WELD FRACTOGRAPHY

BETA LAB No. M10198, TESORO LS2 AND LS2/CS2 TEE FINDINGS PART: 6600-E HEAT EXCHANGER, LS2 22 IN, 36.5 IN MOUNTS, LS2 T2L SEM FRACTOGRAPHY AND PART 22 LS2-CS2 TEE FINDINGS PARTS 16-1 AND 22	TESORO REFINING AND MARKETING COMPANY ANACORTES REFINERY 10200 W. MARCH POINT ROAD T91WA4428 ANACORTES, WA 98221	CUSTOMER P.O. No.: 4501667904
		DATE: OCTOBER 13, 2010
		PAGE 25 OF 56

LABORATORY REPORT

T2L SEM

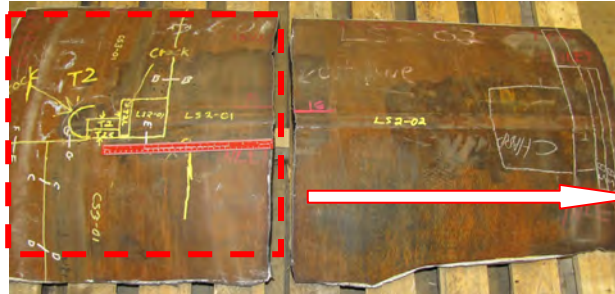

Location of the LS2 marked zone on Part 16-1

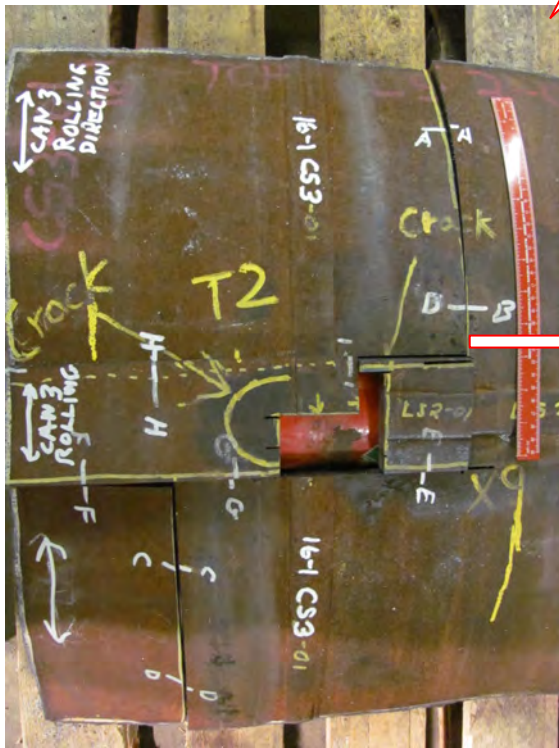
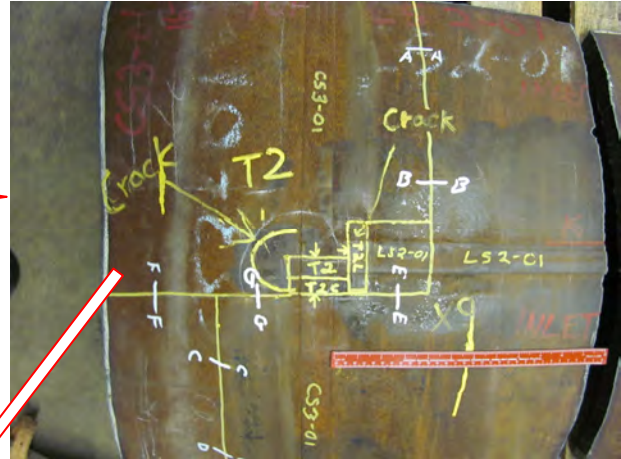

The samples for mounting are cut out

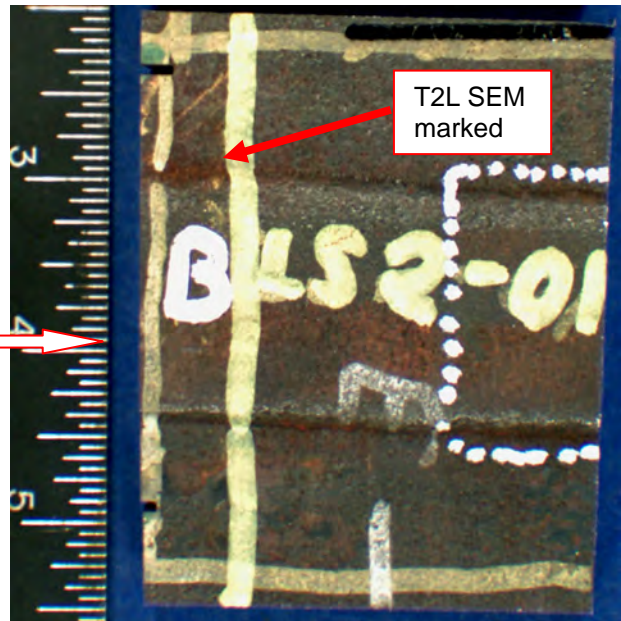
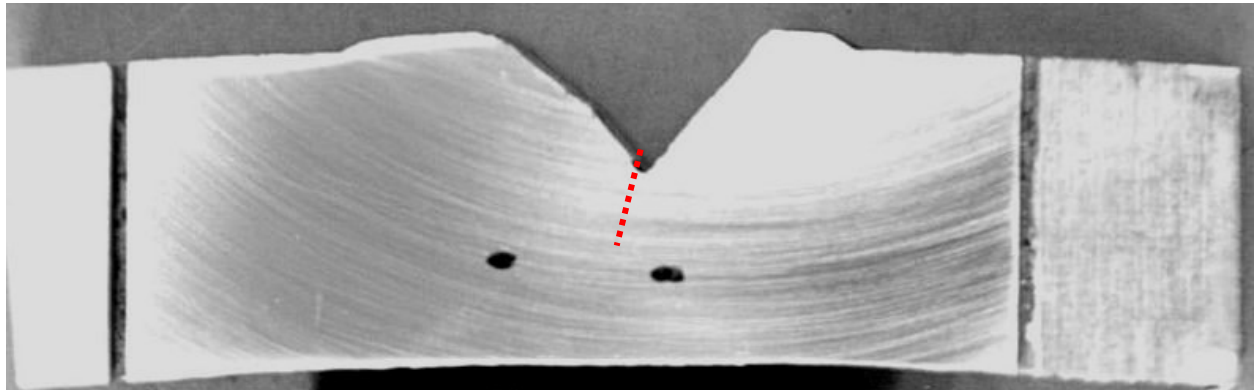

Figure 17

BETA LAB NO. M10198, TESORO LS2 AND LS2/CS2 TEE FINDINGS PART: 6600-E HEAT EXCHANGER, LS2 22 IN, 36.5 IN MOUNTS, LS2 T2L SEM FRACTOGRAPHY AND PART 22 LS2-CS2 TEE FINDINGS PARTS 16-1 AND 22	TESORO REFINING AND MARKETING COMPANY ANACORTES REFINERY 10200 W. MARCH POINT ROAD T91WA4428 ANACORTES, WA 98221	CUSTOMER P.O. No.: 4501667904
		DATE: OCTOBER 13, 2010
		PAGE 26 OF 56

LABORATORY REPORT

T2L SEM



T2L SEM sample before break. The dotted line shows approximate location of the saw cut to facilitate the break. Two black dots are markers of approximate location of the crack tips.

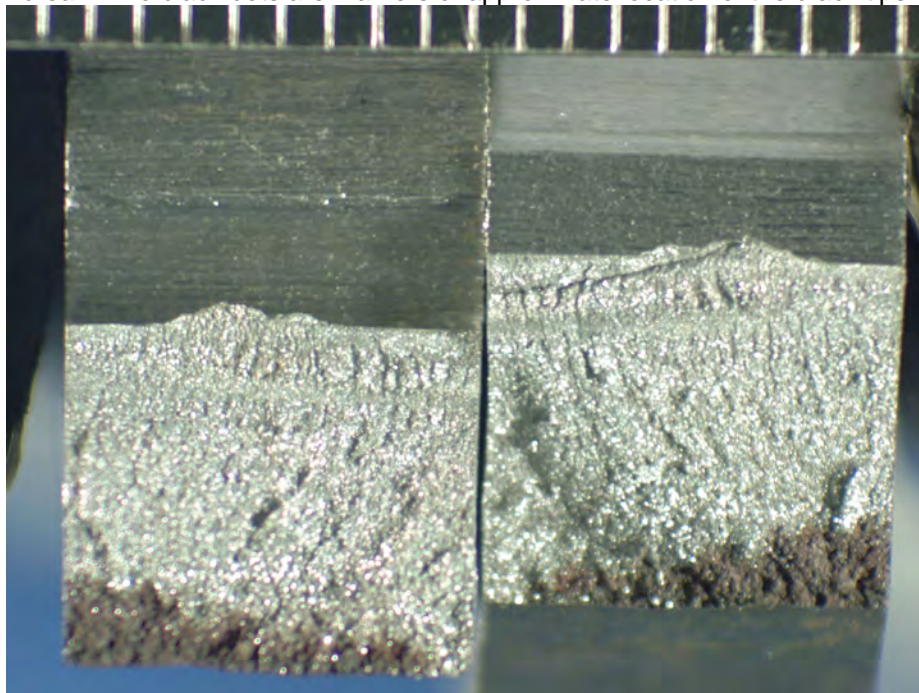

Fracture surfaces of the T2L sample after break. The sample on the right was evaluated in the SEM.

Figure 18

BETA LAB NO. M10198, TESORO LS2 AND LS2/CS2 TEE FINDINGS PART: 6600-E HEAT EXCHANGER, LS2 22 IN, 36.5 IN MOUNTS, LS2 T2L SEM FRACTOGRAPHY AND PART 22 LS2-CS2 TEE FINDINGS PARTS 16-1 AND 22	TESORO REFINING AND MARKETING COMPANY ANACORTES REFINERY 10200 W. MARCH POINT ROAD T91WA4428 ANACORTES, WA 98221	CUSTOMER P.O. No.: 4501667904
		DATE: OCTOBER 13, 2010
		PAGE 27 OF 56

LABORATORY REPORT

T2L SEM

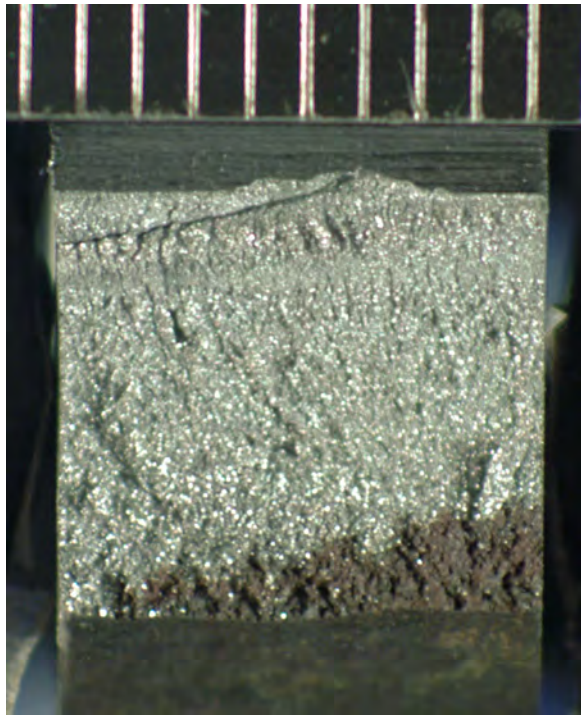

T2L SEM Fracture surface

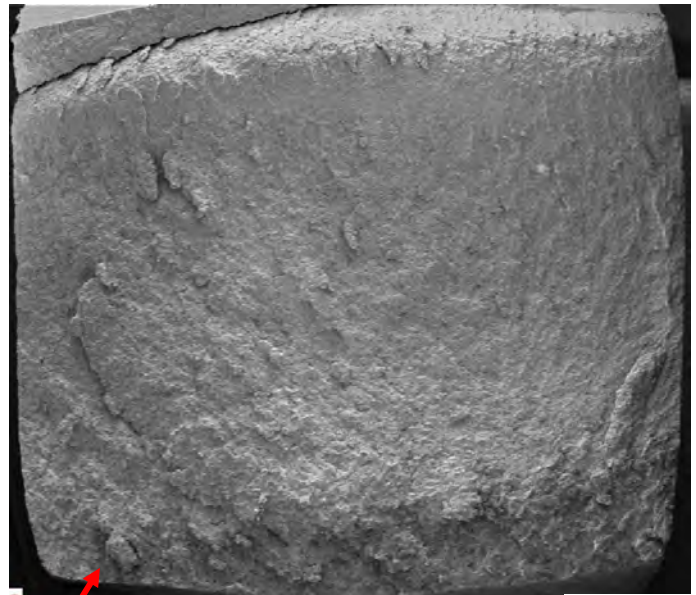

ID Side

SEM image of the fracture surface at left

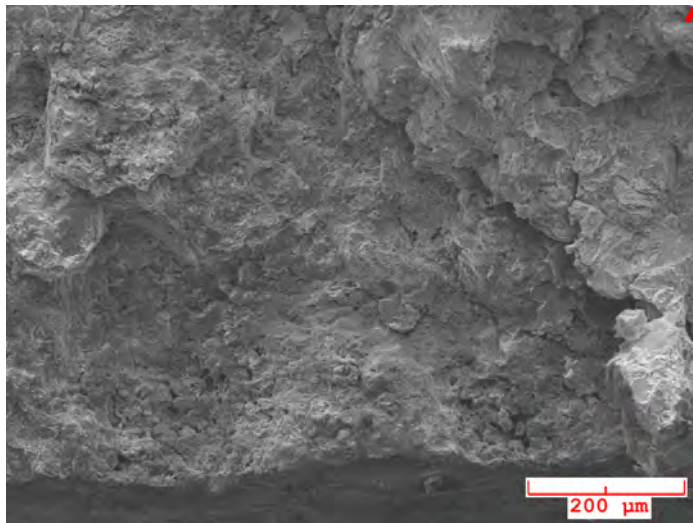

SEM fracture at ID

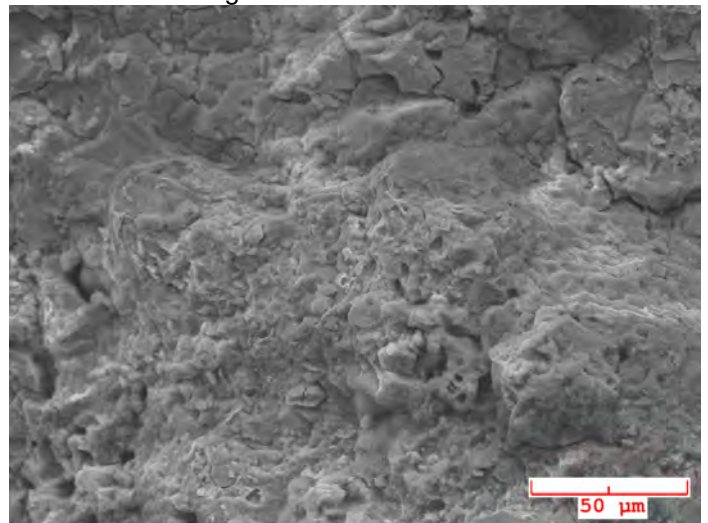

Same as at left at higher magnification

Figure 19

BETA LAB NO. M10198, TESORO LS2 AND LS2/CS2 TEE FINDINGS PART: 6600-E HEAT EXCHANGER, LS2 22 IN, 36.5 IN MOUNTS, LS2 T2L SEM FRACTOGRAPHY AND PART 22 LS2-CS2 TEE FINDINGS PARTS 16-1 AND 22	TESORO REFINING AND MARKETING COMPANY ANACORTES REFINERY 10200 W. MARCH POINT ROAD T91WA4428 ANACORTES, WA 98221	CUSTOMER P.O. No.: 4501667904
		DATE: OCTOBER 13, 2010
		PAGE 28 OF 56

LABORATORY REPORT
T2L SEM

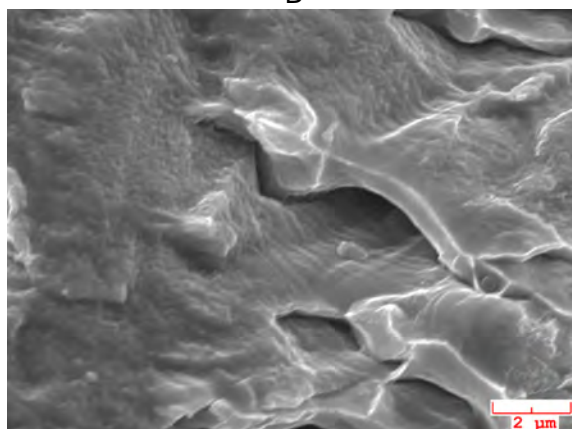
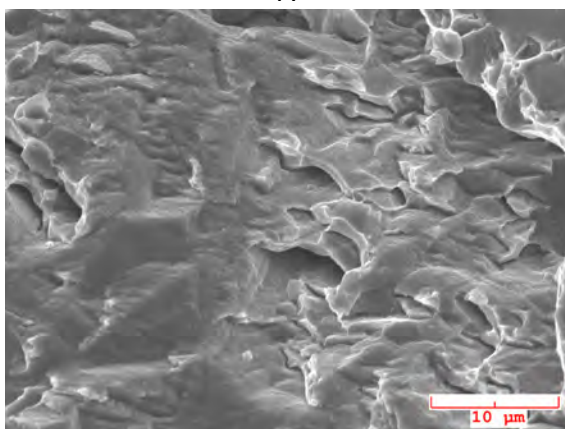
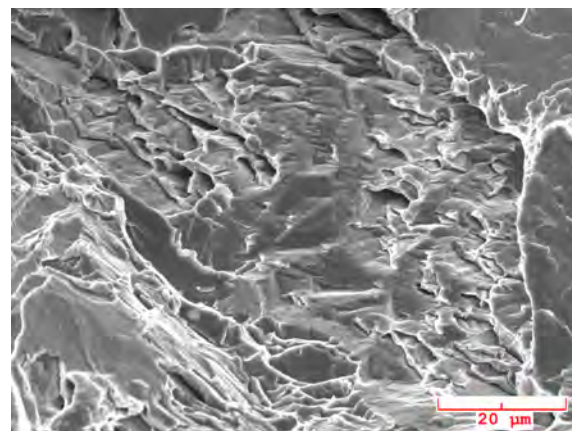
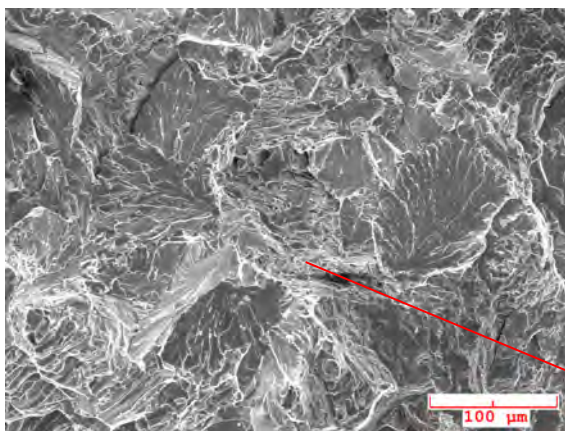
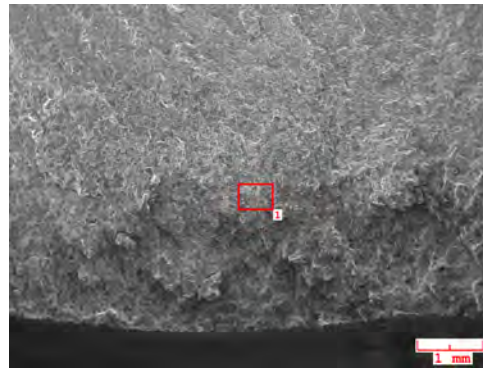

A

B

C

D

Area 1 at different magnifications

Figure 20

BETA LAB No. M10198, TESORO LS2 AND LS2/CS2 TEE FINDINGS PART: 6600-E HEAT EXCHANGER, LS2 22 IN, 36.5 IN MOUNTS, LS2 T2L SEM FRACTOGRAPHY AND PART 22 LS2-CS2 TEE FINDINGS PARTS 16-1 AND 22	TESORO REFINING AND MARKETING COMPANY ANACORTES REFINERY 10200 W. MARCH POINT ROAD T91WA4428 ANACORTES, WA 98221	CUSTOMER P.O. No.: 4501667904
		DATE: OCTOBER 13, 2010
		PAGE 29 OF 56

LABORATORY REPORT

T2L SEM



A. Area evaluated

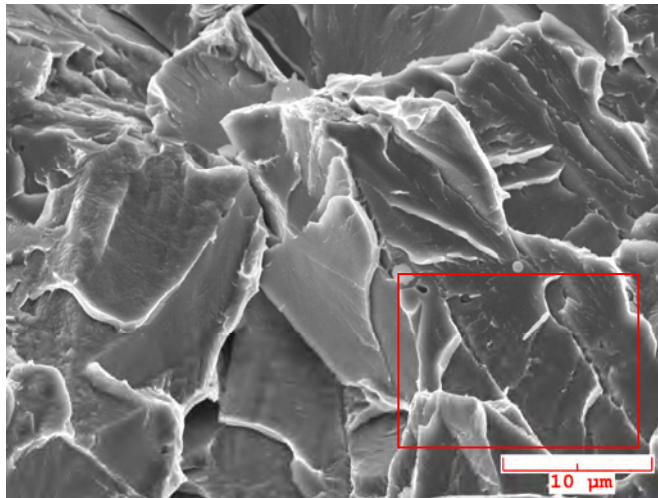

B. Area marked in [A] at higher magnification

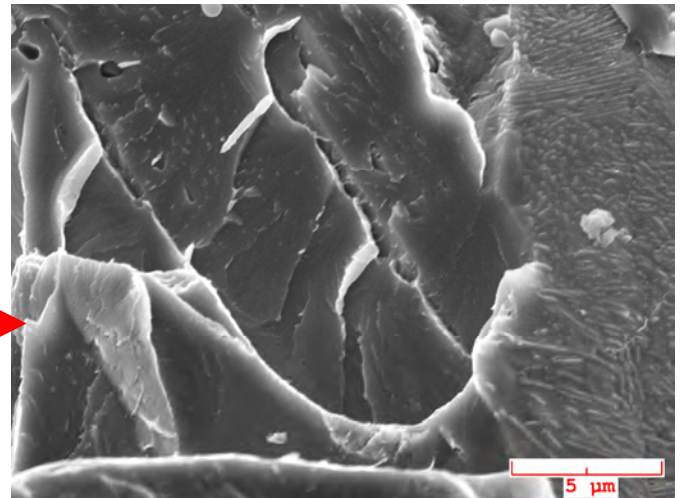

C. The same area as at left at higher magnification

Figure 21

BETA LAB No.M10198, TESORO LS2 AND LS2/CS2 TEE FINDINGS	TESORO REFINING AND MARKETING COMPANY ANACORTES REFINERY 10200 W. MARCH POINT ROAD T91WA4428 ANACORTES, WA 98221	CUSTOMER P.O. No.: 4501667904
PART: 6600-E HEAT EXCHANGER, LS2 22 IN, 36.5 IN MOUNTS, LS2 T2L SEM FRACTOGRAPHY AND PART 22 LS2-CS2 TEE FINDINGS PARTS 16-1 AND 22		DATE: OCTOBER 13, 2010
		PAGE 30 OF 56

LABORATORY REPORT

PART 22 AT 84 INCHES
SAMPLES LS2-A AND
CS2-A

BETA LAB No. M10198, TESORO LS2 AND LS2/CS2 TEE FINDINGS PART: 6600-E HEAT EXCHANGER, LS2 22 IN, 36.5 IN MOUNTS, LS2 T2L SEM FRACTOGRAPHY AND PART 22 LS2-CS2 TEE FINDINGS PARTS 16-1 AND 22	TESORO REFINING AND MARKETING COMPANY ANACORTES REFINERY 10200 W. MARCH POINT ROAD T91WA4428 ANACORTES, WA 98221	CUSTOMER P.O. No.: 4501667904
		DATE: OCTOBER 13, 2010
		PAGE 31 OF 56

LABORATORY REPORT

PART 22 SAMPLES

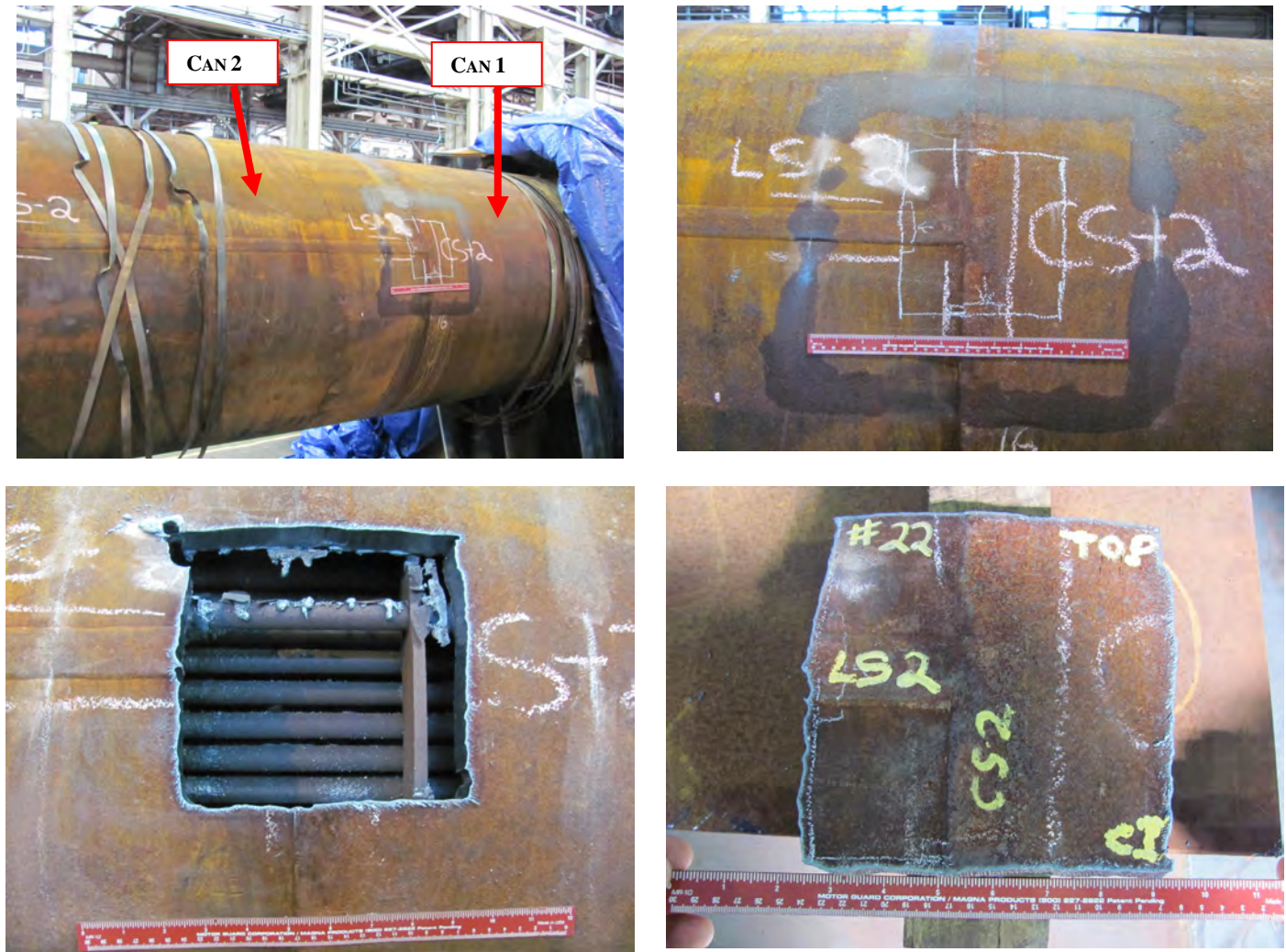
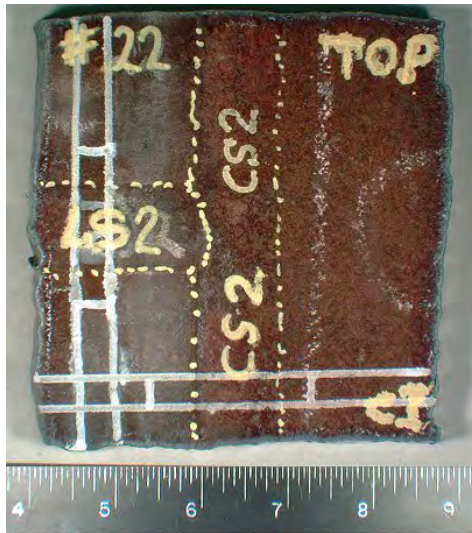

Figure 22

BETA LAB No. M10198, TESORO LS2 AND LS2/CS2 TEE FINDINGS PART: 6600-E HEAT EXCHANGER, LS2 22 IN, 36.5 IN MOUNTS, LS2 T2L SEM FRACTOGRAPHY AND PART 22 LS2-CS2 TEE FINDINGS PARTS 16-1 AND 22	TESORO REFINING AND MARKETING COMPANY ANACORTES REFINERY 10200 W. MARCH POINT ROAD T91WA4428 ANACORTES, WA 98221	CUSTOMER P.O. No.: 4501667904
		DATE: OCTOBER 13, 2010
		PAGE 32 OF 56

LABORATORY REPORT

PART 22 SAMPLES



Part 22. View at OD.

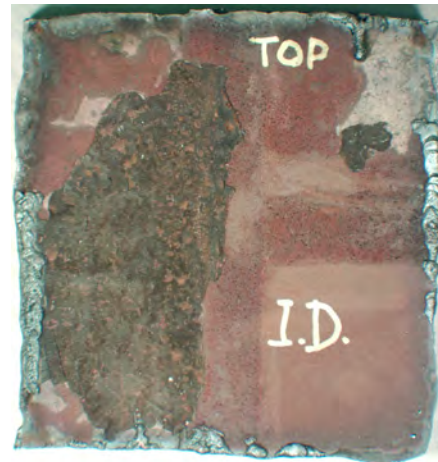

Part 22. View at ID

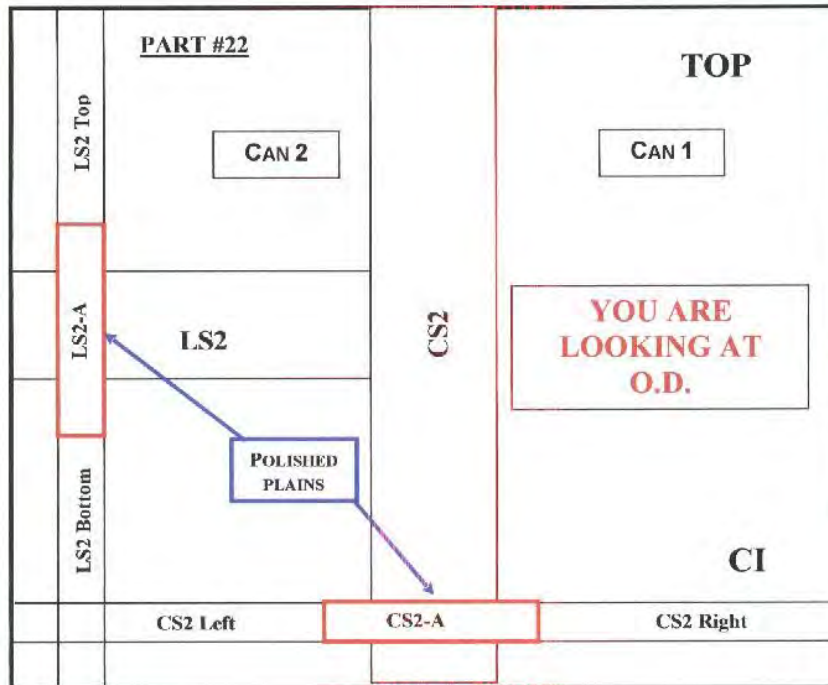

Part 22 sketch with the samples layout

Figure 23

BETA LAB NO. M10198, TESORO LS2 AND LS2/CS2 TEE FINDINGS PART: 6600-E HEAT EXCHANGER, LS2 22 IN, 36.5 IN MOUNTS, LS2 T2L SEM FRACTOGRAPHY AND PART 22 LS2-CS2 TEE FINDINGS PARTS 16-1 AND 22	TESORO REFINING AND MARKETING COMPANY ANACORTES REFINERY 10200 W. MARCH POINT ROAD T91WA4428 ANACORTES, WA 98221	CUSTOMER P.O. No.: 4501667904
		DATE: OCTOBER 13, 2010
		PAGE 33 OF 56

**LABORATORY REPORT
PART 22 SAMPLES**



Macro-photograph of the LS2-A mount



Macro-photograph of the CS2-A mount

Figure 24

BETA LAB NO. M10198, TESORO LS2 AND LS2/CS2 TEE FINDINGS PART: 6600-E HEAT EXCHANGER, LS2 22 IN, 36.5 IN MOUNTS, LS2 T2L SEM FRACTOGRAPHY AND PART 22 LS2-CS2 TEE FINDINGS PARTS 16-1 AND 22	TESORO REFINING AND MARKETING COMPANY ANACORTES REFINERY 10200 W. MARCH POINT ROAD T91WA4428 ANACORTES, WA 98221	CUSTOMER P.O. No.: 4501667904
		DATE: OCTOBER 13, 2010
		PAGE 34 OF 56

LABORATORY REPORT
PART 22 SAMPLES
MOUNT LS2-A

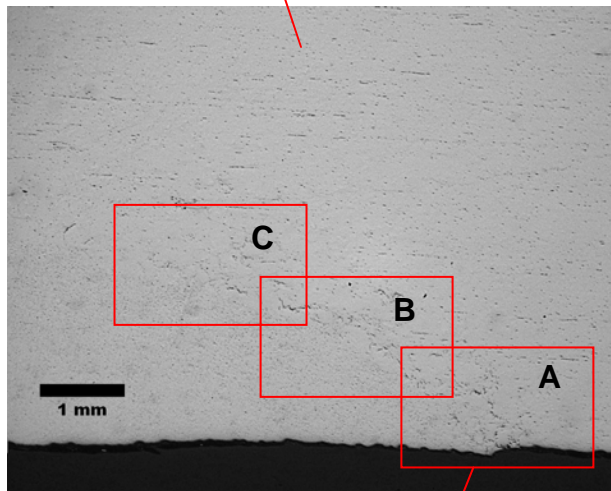

A. Toe of the weld. Un-etched

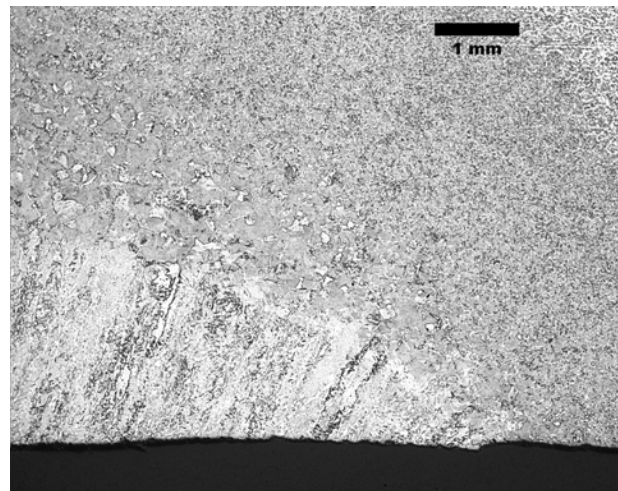

B. Same as at left. Etched

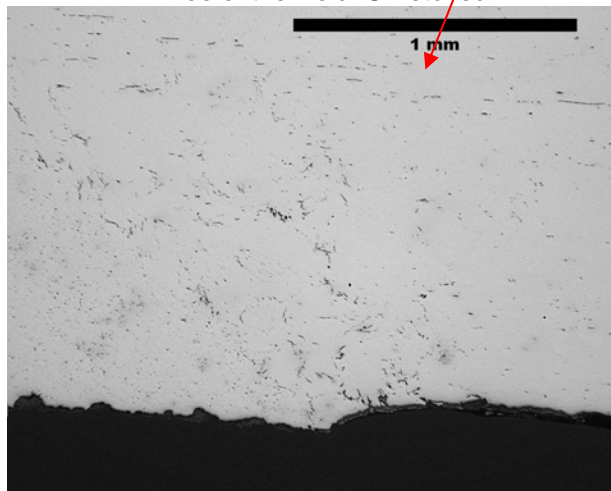

C. Toe of the weld in the marked area A above. Un-etched

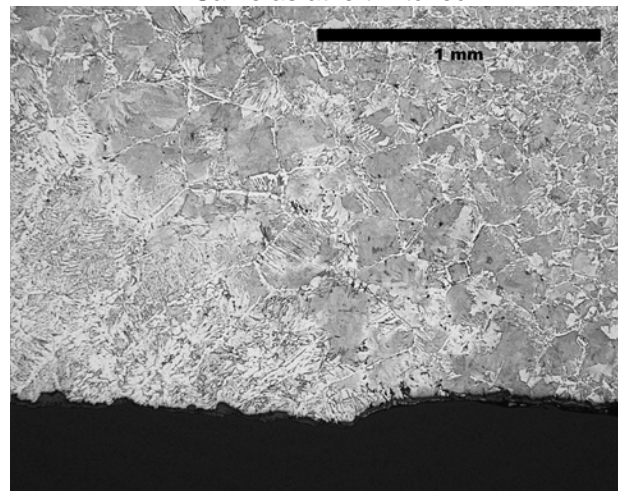

D. Same as at left. Etched

Figure 25. Enlarged areas in the rectangles are shown on Figure 26 A&B, and 26 C&D. Locations are approximate.

BETA LAB NO. M10198, TESORO LS2 AND LS2/CS2
TEE FINDINGS
PART: 6600-E HEAT EXCHANGER, LS2 22 IN, 36.5 IN
MOUNTS, LS2 T2L SEM FRACTOGRAPHY AND PART
22 LS2-CS2 TEE FINDINGS PARTS 16-1 AND 22

TESORO REFINING AND MARKETING COMPANY
ANACORTES REFINERY
10200 W. MARCH POINT ROAD T91WA4428
ANACORTES, WA 98221

CUSTOMER P.O. No.: 4501667904

DATE: OCTOBER 13, 2010

PAGE 35 OF 56

LABORATORY REPORT

**PART 22 SAMPLES
MOUNT LS2-A**

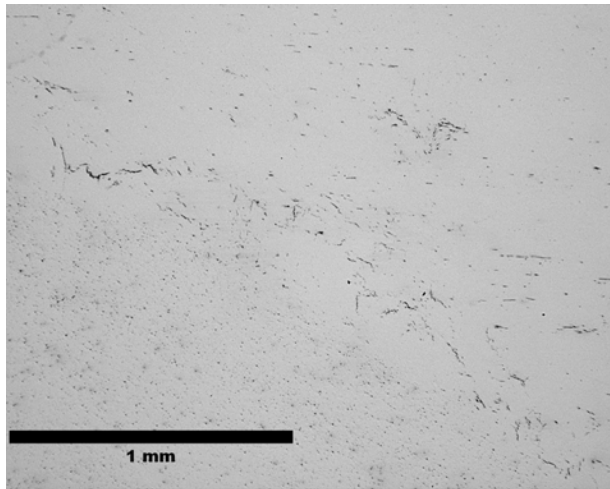

A. Area along the fusion line (see Fig. 25, area B).
Un-etched

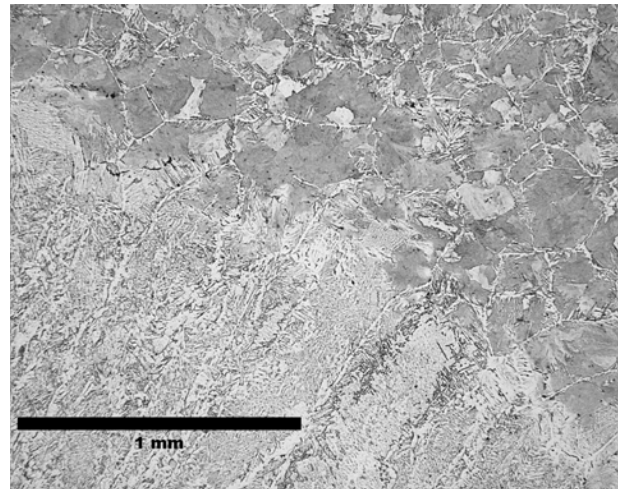

B. Same as at left, etched

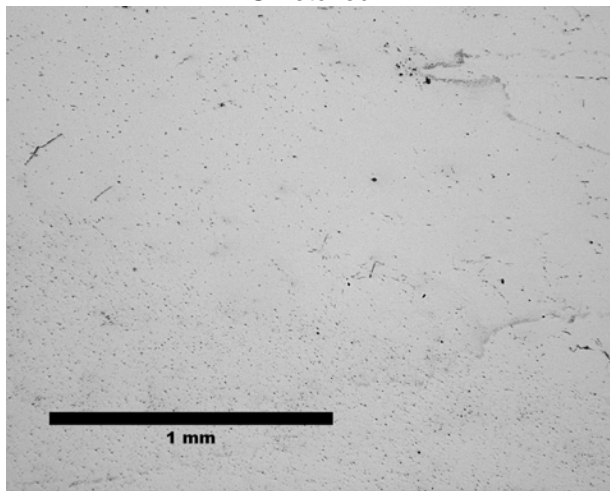

C. Area along the fusion line (see Fig. 25, area C).
Un-etched

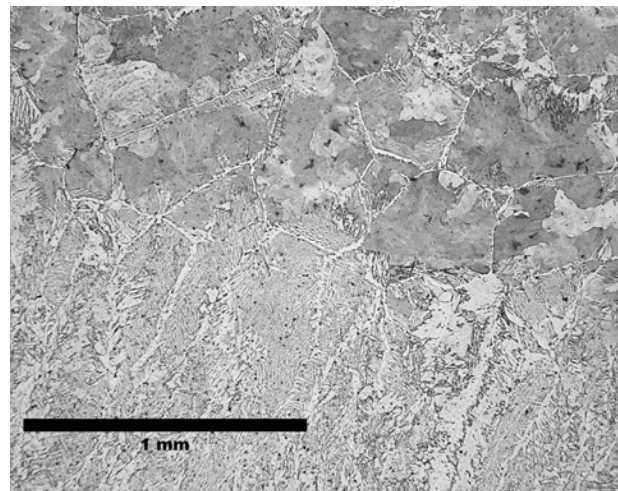

D. Same as at left, etched

Figure 26

BETA LAB NO. M10198, TESORO LS2 AND LS2/CS2 TEE FINDINGS PART: 6600-E HEAT EXCHANGER, LS2 22 IN, 36.5 IN MOUNTS, LS2 T2L SEM FRACTOGRAPHY AND PART 22 LS2-CS2 TEE FINDINGS PARTS 16-1 AND 22	TESORO REFINING AND MARKETING COMPANY ANACORTES REFINERY 10200 W. MARCH POINT ROAD T91WA4428 ANACORTES, WA 98221	CUSTOMER P.O. No.: 4501667904
		DATE: OCTOBER 13, 2010
		PAGE 36 OF 56

LABORATORY REPORT
PART 22 SAMPLES
MOUNT LS2-A

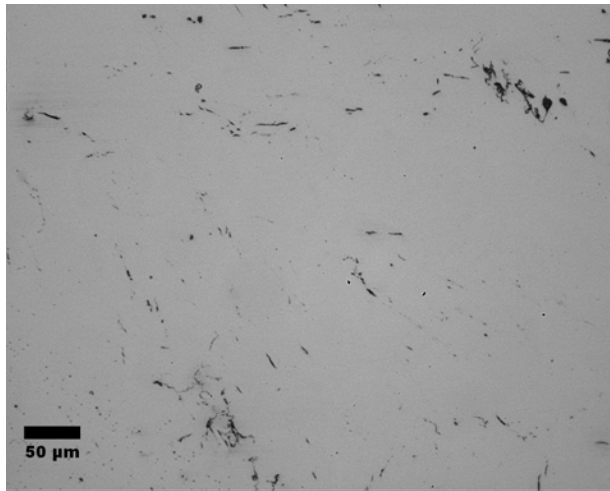

A. Enlarged area near the toe of the weld. Un-etched

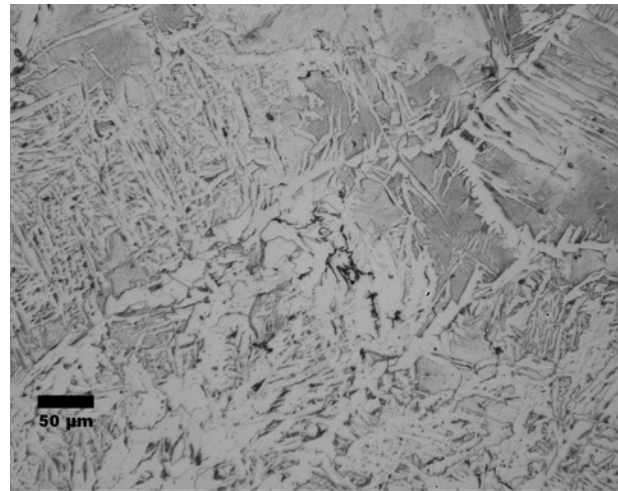

B. Same as at left, etched

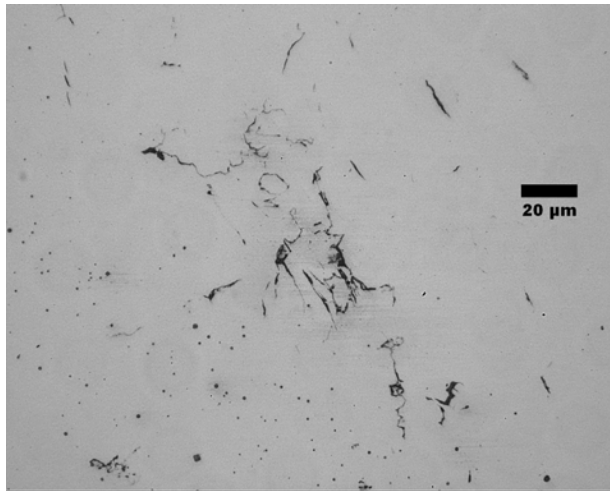

C. Enlarged area near the toe of the weld. Un-etched

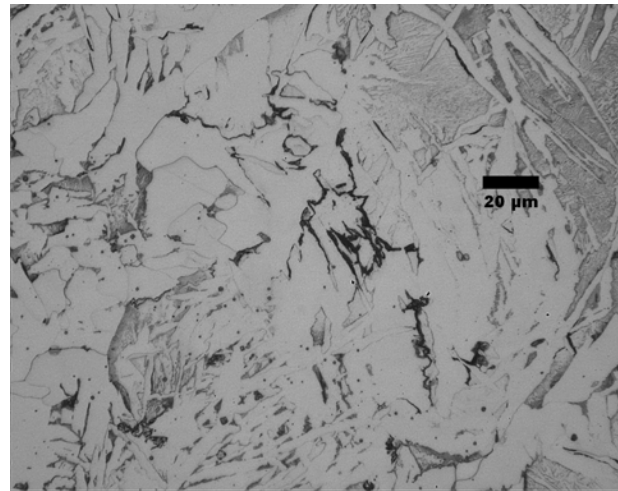

D. Same as at left, etched

Figure 27

BETA LAB No. M10198, TESORO LS2 AND LS2/CS2 TEE FINDINGS PART: 6600-E HEAT EXCHANGER, LS2 22 IN, 36.5 IN MOUNTS, LS2 T2L SEM FRACTOGRAPHY AND PART 22 LS2-CS2 TEE FINDINGS PARTS 16-1 AND 22	TESORO REFINING AND MARKETING COMPANY ANACORTES REFINERY 10200 W. MARCH POINT ROAD T91WA4428 ANACORTES, WA 98221	CUSTOMER P.O. No.: 4501667904
		DATE: OCTOBER 13, 2010
		PAGE 37 OF 56

**LABORATORY REPORT
PART 22 SAMPLES
MOUNT LS2-A**

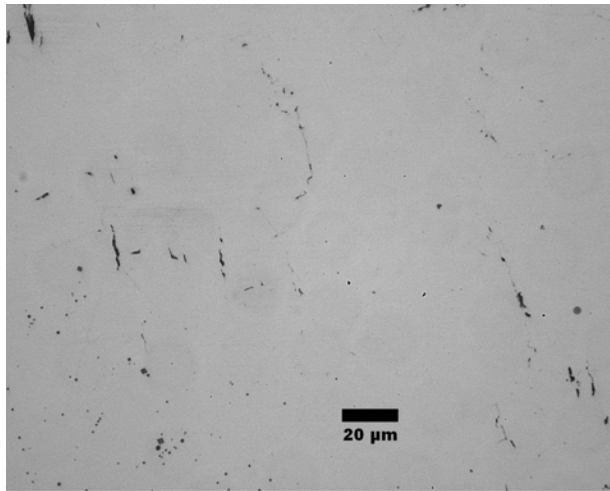

A. Enlarged area near the toe of the weld. Un-etched

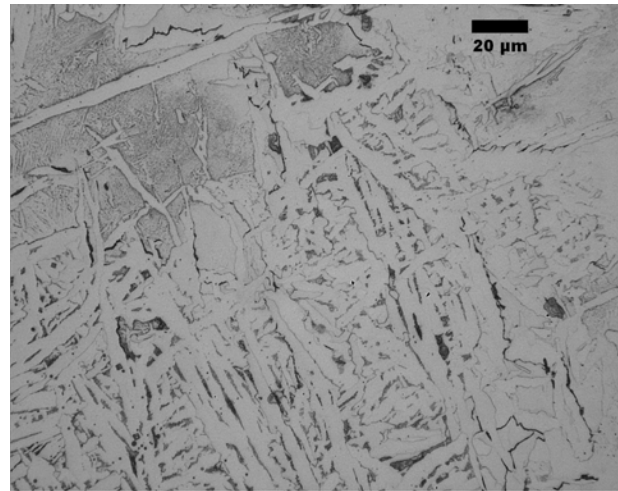

B. Same as at left, etched

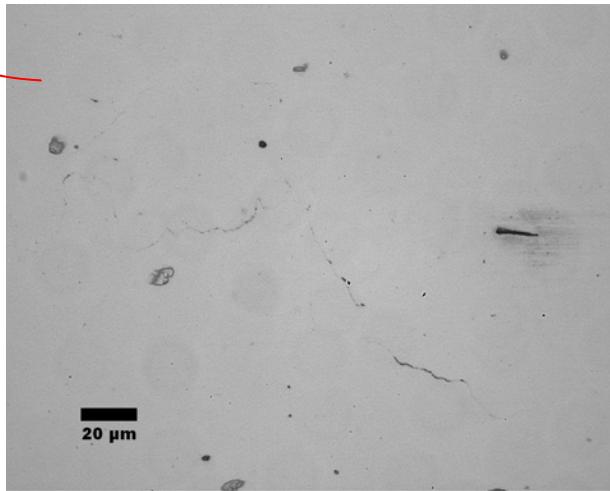

C. Area approximately at midpoint between ID and the cusp. Un-etched

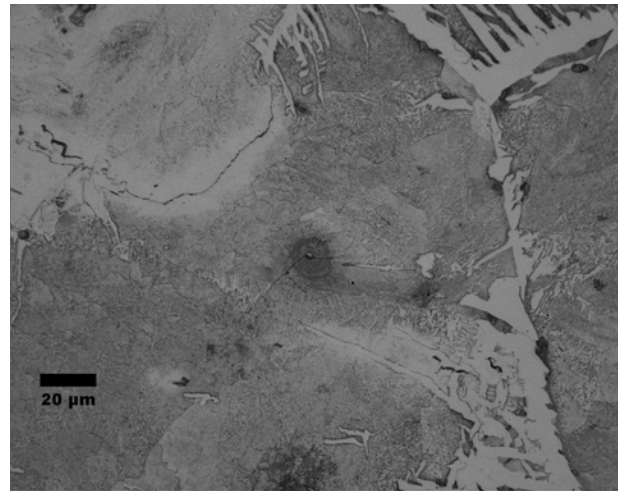

D. Same as at left, etched

Figure 28

BETA LAB NO. M10198, TESORO LS2 AND LS2/CS2
 TEE FINDINGS
 PART: 6600-E HEAT EXCHANGER, LS2 22 IN, 36.5 IN
 MOUNTS, LS2 T2L SEM FRACTOGRAPHY AND PART
 22 LS2-CS2 TEE FINDINGS PARTS 16-1 AND 22

TESORO REFINING AND MARKETING COMPANY
 ANACORTES REFINERY
 10200 W. MARCH POINT ROAD T91WA4428
 ANACORTES, WA 98221

CUSTOMER P.O. No.: 4501667904

DATE: OCTOBER 13, 2010

PAGE 38 OF 56

LABORATORY REPORT
PART 22 SAMPLES
MOUNT LS2-A

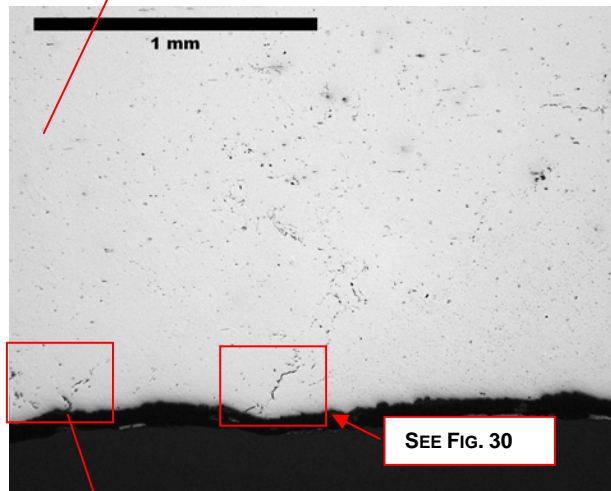

A. Area at arrow. Un-etched

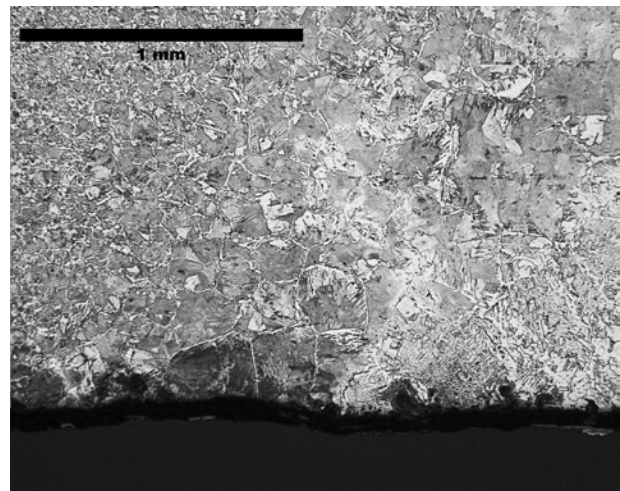

B. Same as at left. Etched

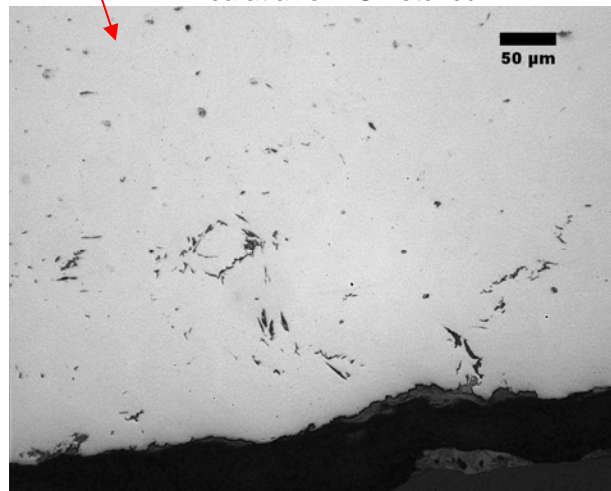

C. Enlarged area from [A] above. Un-etched

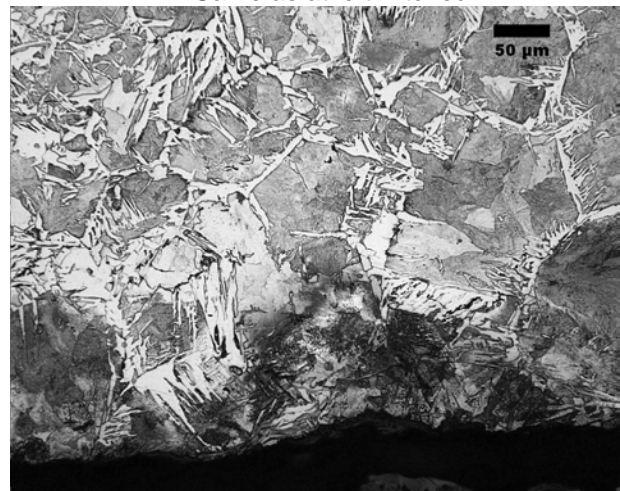

D. Same as at left. Etched

Figure 29

BETA LAB NO. M10198, TESORO LS2 AND LS2/CS2 TEE FINDINGS PART: 6600-E HEAT EXCHANGER, LS2 22 IN, 36.5 IN MOUNTS, LS2 T2L SEM FRACTOGRAPHY AND PART 22 LS2-CS2 TEE FINDINGS PARTS 16-1 AND 22	TESORO REFINING AND MARKETING COMPANY ANACORTES REFINERY 10200 W. MARCH POINT ROAD T91WA4428 ANACORTES, WA 98221	CUSTOMER P.O. No.: 4501667904
		DATE: OCTOBER 13, 2010
		PAGE 39 OF 56

**LABORATORY REPORT
PART 22 SAMPLES
MOUNT LS2-A**

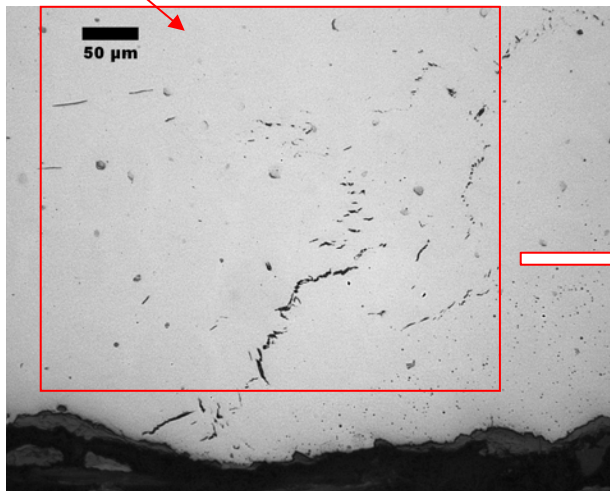

A. Enlarged area from Figure 29 above. Un-etched



B. Same as at left, slightly enlarged. Etched

**PART 22 SAMPLES
MOUNT CS2-A**

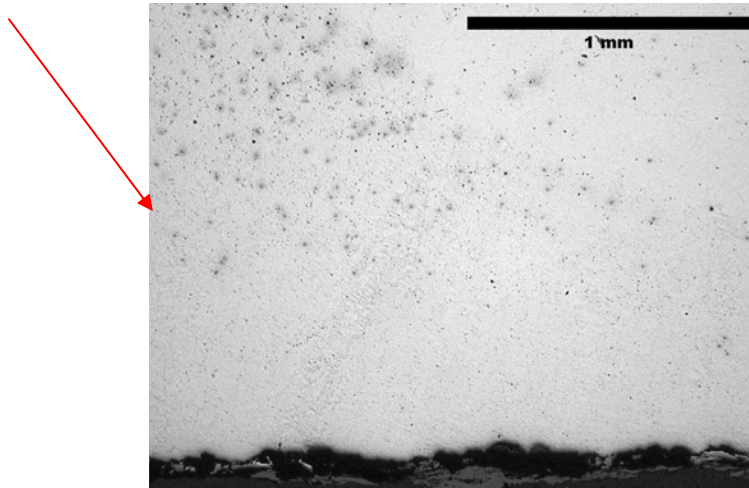

Toe of the weld. No damage found on CS2-A mount. Typical. Un-etched

Figure 30

BETA LAB NO. M10198, TESORO LS2 AND LS2/CS2 TEE FINDINGS
 PART: 6600-E HEAT EXCHANGER, LS2 22 IN, 36.5 IN MOUNTS, LS2 T2L SEM FRACTOGRAPHY AND PART 22 LS2-CS2 TEE FINDINGS PARTS 16-1 AND 22

TESORO REFINING AND MARKETING COMPANY
 ANACORTES REFINERY
 10200 W. MARCH POINT ROAD T91WA4428
 ANACORTES, WA 98221

CUSTOMER P.O. No.: 4501667904

DATE: OCTOBER 13, 2010

PAGE 40 OF 56

LABORATORY REPORT

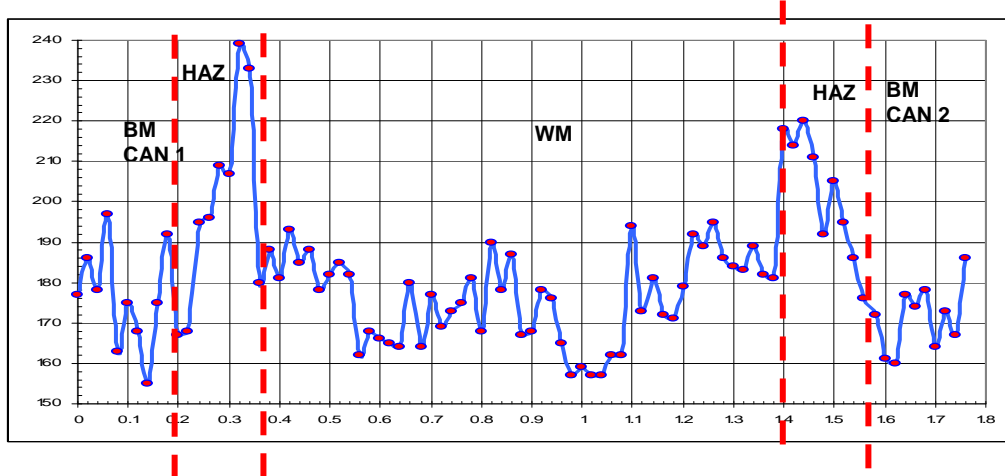

HARDNESS
HV⁵⁰⁰
TRAVERSE
O.D. LINE

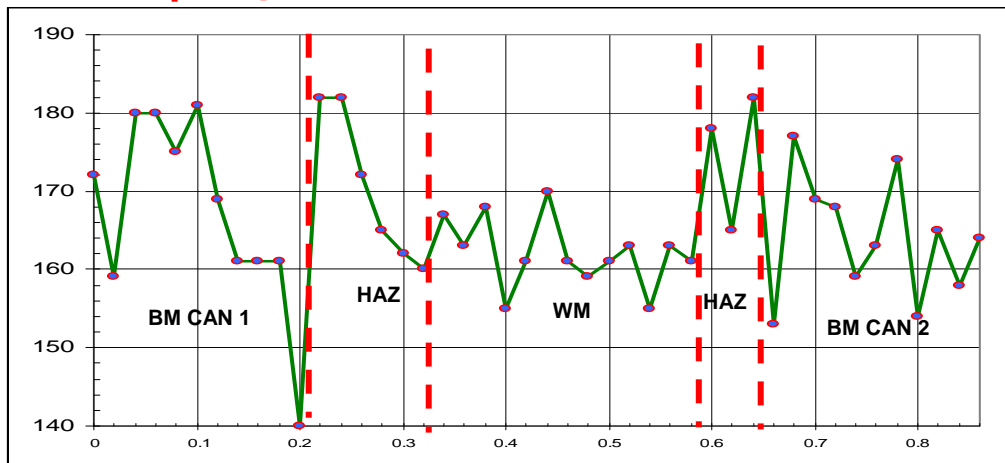

HARDNESS
HV⁵⁰⁰
TRAVERSE
CUSP LINE

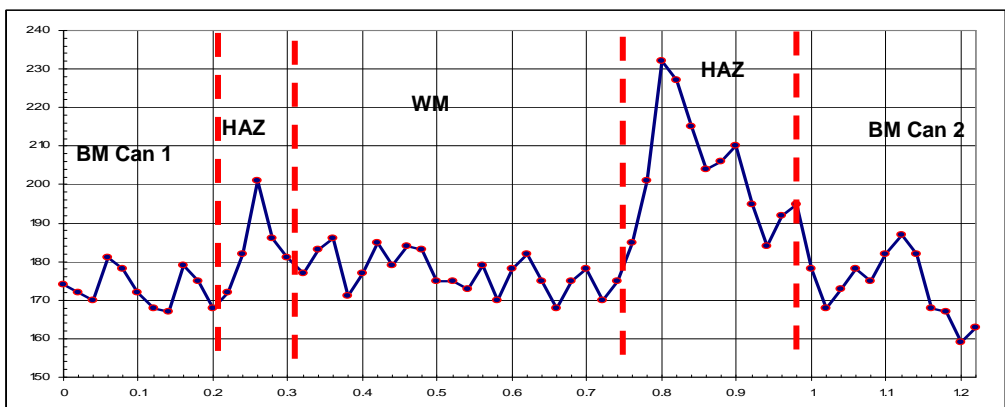

HARDNESS
HV⁵⁰⁰
TRAVERSE
I.D. LINE

BM – Base Metal, HAZ – Heat Affected Zone, WM – Weld Metal
Figure 31. CS2-A hardness measurements results.

BETA LAB No. M10198, TESORO LS2 AND LS2/CS2 TEE FINDINGS PART: 6600-E HEAT EXCHANGER, LS2 22 IN, 36.5 IN MOUNTS, LS2 T2L SEM FRACTOGRAPHY AND PART 22 LS2-CS2 TEE FINDINGS PARTS 16-1 AND 22	TESORO REFINING AND MARKETING COMPANY ANACORTES REFINERY 10200 W. MARCH POINT ROAD T91WA4428 ANACORTES, WA 98221	CUSTOMER P.O. No.: 4501667904
		DATE: OCTOBER 13, 2010
		PAGE 41 OF 56

**LABORATORY REPORT
T2L MOUNT (LS2 WELD)**

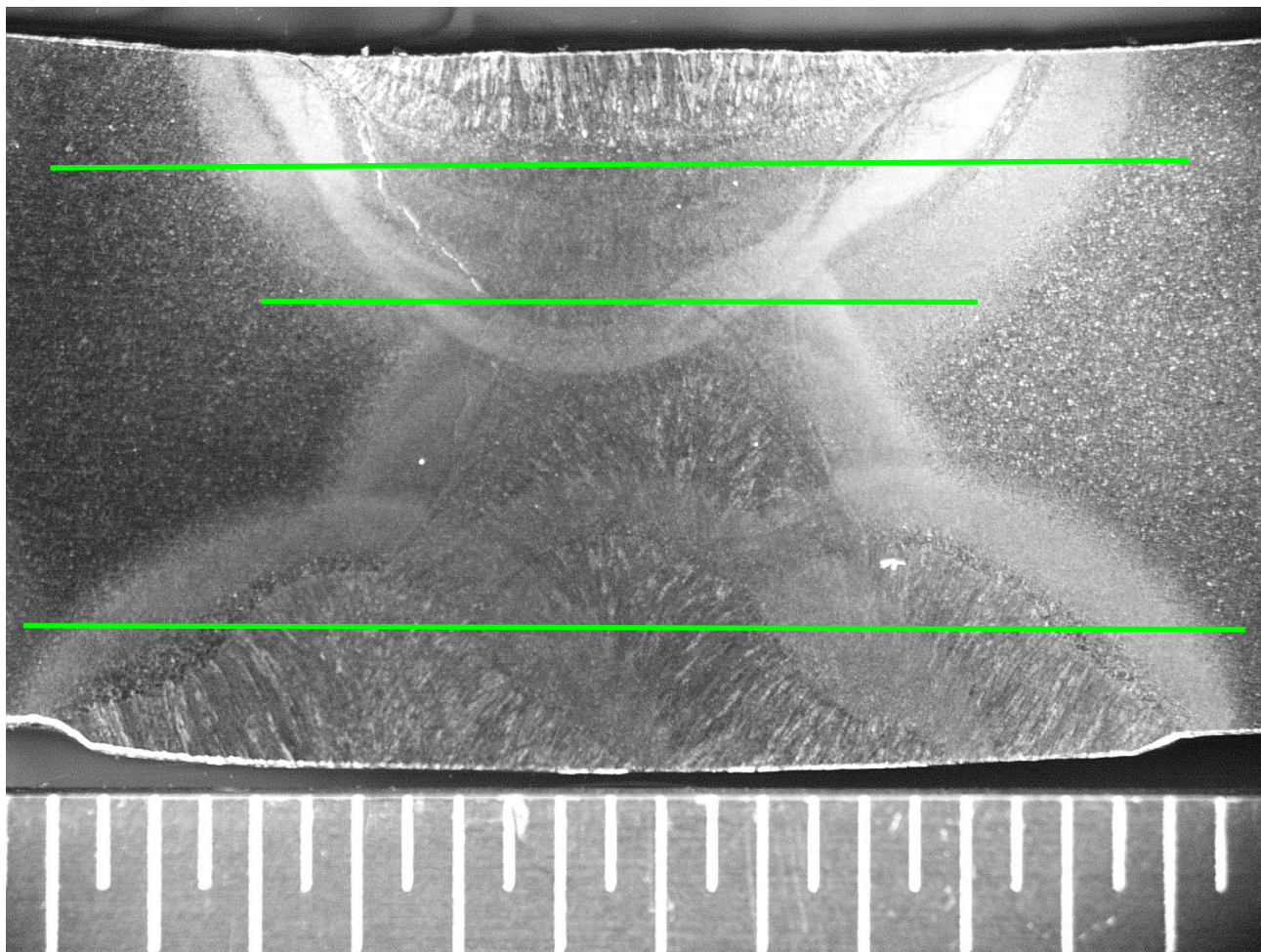

Mount T2L transverse through -
 Photo macrographs with green lines where the micro-hardness traverses were made. Hardness values are given in Table 3 & 5. The scale marks are 1/16inch. (Data are from Report M10198 Tesoro LS2-CS3 Tee Indications Findings, August 13, 2010). ID is on the top.

Figure 32.

BETA LAB NO. M10198, TESORO LS2 AND LS2/CS2 TEE FINDINGS PART: 6600-E HEAT EXCHANGER, LS2 22 IN, 36.5 IN MOUNTS, LS2 T2L SEM FRACTOGRAPHY AND PART 22 LS2-CS2 TEE FINDINGS PARTS 16-1 AND 22	TESORO REFINING AND MARKETING COMPANY ANACORTES REFINERY 10200 W. MARCH POINT ROAD T91WA4428 ANACORTES, WA 98221	CUSTOMER P.O. No.: 4501667904
		DATE: OCTOBER 13, 2010
		PAGE 42 OF 56

LABORATORY REPORT

CS2-A MOUNT (CS2 WELD)

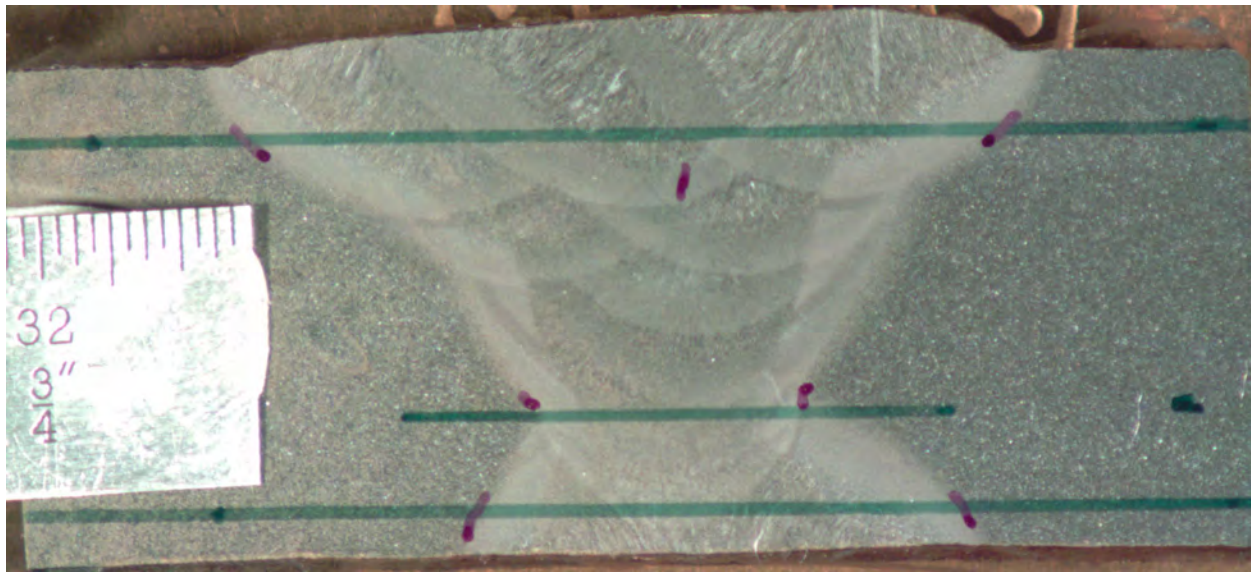

Figure 33

Photo macrograph with green lines where the micro-hardness traverses were made. Hardness values are given in Table 4 & 5, Graphs on Figure 31. . ID is on the bottom.

BETA LAB NO. M10198, TESORO LS2 AND LS2/CS2 TEE FINDINGS PART: 6600-E HEAT EXCHANGER, LS2 22 IN, 36.5 IN MOUNTS, LS2 T2L SEM FRACTOGRAPHY AND PART 22 LS2-CS2 TEE FINDINGS PARTS 16-1 AND 22	TESORO REFINING AND MARKETING COMPANY ANACORTES REFINERY 10200 W. MARCH POINT ROAD T91WA4428 ANACORTES, WA 98221	CUSTOMER P.O. No.: 4501667904
		DATE: OCTOBER 13, 2010
		PAGE 43 OF 56

LABORATORY REPORT

ATTACHMENT 1 TEST PROTOCOL AND ADDENDUM

Tesoro Exchanger E Failure Examination Protocol

Part 1. Field Visual and Nondestructive Examination

Part 1 of this protocol identifies visual and non-destructive testing that is approved to be conducted on the shell of exchanger 6600-E by a contractor acceptable to the parties to this agreement. Prior to performing any visual inspection or non-destructive testing, 3 business days notice must be provided to all parties to the agreement to allow the opportunity to observe. Parties to this agreement may elect not to perform aspects of the visual inspection or non-destructive testing described in this protocol. Should parties identify the need to conduct additional inspection or non-destructive testing not described in Part 1 of this protocol, 2 days notice must be provided to all parties to this agreement in order to register any objections.

Detailed visual inspection and testing will not be permitted until the equipment is placed in the secure evidence storage location.

All field visual and nondestructive tests shall be appropriately documented indicating examinations performed, scope of examinations, test equipment used in examinations, results of testing and the qualifications of the examiner as appropriate. All reports will be signed and dated by the examiner(s). Data reports shall be distributed within 48 hours of examinations by the third party conducting these examinations to all parties simultaneously. No party shall have the opportunity to review any data results in advance of the other parties. Any part requesting clarification or correction of anything in the report shall submit their request to all parties.

Data generated as a result of the execution of this protocol will be shared with all parties to the agreement simultaneously. Visual inspection reports, analysis or conclusion will not be shared.

Each party conducting field visual and nondestructive examination shall be assigned a unique set of alpha-numeric sets of markings. The format of the markings shall be AXXX, BXXX, CXXX, etc. The markings shall be applied to the external surfaces of the shell only and shall be permanent in nature (etch, stamp, etc.). Any markings shall be applied at least two (2) inches from any fracture surface. The markings shall be used for purposes described in Part 1 of this protocol and may also be used to identify locations of specific areas of interest determined by any examination conducted in Part 1. Each party using the markings shall supply a drawing identifying unique markings used and locations of these markings on the shell for information to all parties.

Field Visual Examination

1. Photographically document the heat exchanger in the "as-found" condition before initiating the metallurgical analysis. Documentation should include the following:
 - Any reference points needed
 - Fracture area and surface
 - Seams

BETA LAB NO. M10198, TESORO LS2 AND LS2/CS2 TEE FINDINGS PART: 6600-E HEAT EXCHANGER, LS2 22 IN, 36.5 IN MOUNTS, LS2 T2L SEM FRACTOGRAPHY AND PART 22 LS2-CS2 TEE FINDINGS PARTS 16-1 AND 22	TESORO REFINING AND MARKETING COMPANY ANACORTES REFINERY 10200 W. MARCH POINT ROAD T91WA4428 ANACORTES, WA 98221	CUSTOMER P.O. No.: 4501667904
		DATE: OCTOBER 13, 2010
		PAGE 44 OF 56

LABORATORY REPORT

Tesoro Exchanger E Failure Examination Protocol

- Welds
 - Anomalies (dents, cracks, appurtenance)
 - Manufacturing flaws or defects
 - Pitting and/or evidence of corrosion on internal and external surfaces
2. Videotape the failed heat exchanger and surrounding heat exchangers and piping in the “as-found” condition. The videotape should similarly scan all items listed in (1) above. One scan should also offer a panoramic view of all affected surrounding equipment shot from a location immediately adjacent to the point of failure on the failed exchanger.
 3. Perform an initial field visual examination of the internal and external surfaces in the “as-found” condition, and document any anomalies that may be present such as the following:
 - Cracks
 - Crevices
 - Dents
 - Gouges
 - Manufacturing defects
 - Pitting and/or evidence of corrosion on internal and external surfaces
 - Presence of corrosion products and/or deposits
 - Examine the surface for evidence of cracks
 - Examine for evidence of arc burns, grinding around the surface area near the fracture

Additional considerations

- a. Fracture Surfaces: All fracture surfaces should be reviewed and photographed to check for:
 - thinning due to apparent corrosion
 - thinning due to necking
 - scaling (indicating an older crack)
 - beach or ratchet (chevron) marks pointing to the initiation site
 - proximity to welds and whether the crack propagates through weld metal, base metals or HAZs (Heat Affected Zones).
 - proximity to the end of the cladding
 - geometrical anomalies – e.g. gouges, sharp weld corners, mismatch, incomplete penetration of welds, etc
- b. Characterization of Internal Corrosion: Visible thinning or pitting on shell, tubes and baffles. Record description of all visible areas, with:
 - locations of corrosion on shell with length from outlet tubesheet and height from the bottom of the exchanger),
 - appearance of corrosion type on shell – thinning , pitting, etc
 - descriptions of scales
 - estimates of depths of observable corrosion and scales.

BETA LAB NO. M10198, TESORO LS2 AND LS2/CS2 TEE FINDINGS PART: 6600-E HEAT EXCHANGER, LS2 22 IN, 36.5 IN MOUNTS, LS2 T2L SEM FRACTOGRAPHY AND PART 22 LS2-CS2 TEE FINDINGS PARTS 16-1 AND 22	TESORO REFINING AND MARKETING COMPANY ANACORTES REFINERY 10200 W. MARCH POINT ROAD T91WA4428 ANACORTES, WA 98221	CUSTOMER P.O. No.: 4501667904
		DATE: OCTOBER 13, 2010
		PAGE 45 OF 56

LABORATORY REPORT

Tesoro Exchanger E Failure Examination Protocol

- c. Characterization of Fouling or Other Deposits:
 - Describe by color, volume, location, density, tenacity of adhering to surface, whether initiating on tubes or shell.
 - Use initial photos for comparison to see if fouling has been affected by atmospheric and weather exposure in the last few weeks.
 - Report any areas near fracture surface where the fouling seems to be removed due to the flow escaping from the fracture (to help define initial leak point).
- d. Characterization of Distortion – Possible Pre- or Post-Explosion:
 - Look for tube distortion such as pulling out of tubesheet or breaking behind tubesheet or baffles, or having contact with shell.
 - Look for bundle distortion which may be an affect of the explosion, and may indicate the initial leak point.
- e. Tracing Initial Leak Point by Surrounding Impingement or Damage:
 - Inspect adjacent equipment in the direction of the rupture and cracking, and report any signs of flow impingement, high temperature exposures, explosion pressure-wave, etc.

Field Visual and Nondestructive Examination

1. Positive Materials Identification (PMI)

Perform PMI testing on all shell components and full penetration welds within two feet of the fracture surfaces using portable x-ray emission analyzers.

- Conduct all tests on external surfaces at least 6 inches away from all fracture surfaces.
- Conduct one test per weld located in the areas of interest on an external surface at least one foot away from all fracture surfaces.
- Unique numeric markings for identification purposes shall be made on the external surfaces of the shell where any PMI test was conducted.

2. Deposit Collection

Deposits from the lower section of the bundle and representative deposits found adhered to the shell shall be collected and stored in clean glass covered jars for subsequent laboratory analysis. Unique numeric markings for identification purposes shall be made on the external surfaces of the shell and on the surface of the bundle where the deposits were collected. Photographs should be taken of locations where deposits are to be removed prior to removal.

BETA LAB NO. M10198, TESORO LS2 AND LS2/CS2 TEE FINDINGS PART: 6600-E HEAT EXCHANGER, LS2 22 IN, 36.5 IN MOUNTS, LS2 T2L SEM FRACTOGRAPHY AND PART 22 LS2-CS2 TEE FINDINGS PARTS 16-1 AND 22	TESORO REFINING AND MARKETING COMPANY ANACORTES REFINERY 10200 W. MARCH POINT ROAD T91WA4428 ANACORTES, WA 98221	CUSTOMER P.O. No.: 4501667904
		DATE: OCTOBER 13, 2010
		PAGE 46 OF 56

LABORATORY REPORT

Tesoro Exchanger E Failure Examination Protocol

Prior to collection of any samples, 3 business days notice shall be given to all parties to this agreement to provide the opportunity to observe sample collection. Analysis of collected samples must be approved by all parties to the agreement.

3. Field Crack Detection Ultrasonic Testing

Conduct ultrasonic examination adjacent to all fracture surfaces using techniques suitable for stress corrosion cracking or other potential service cracking mechanisms. Phased array is preferred for macro-cracking and AUBT is preferred for fissuring due to HTHA.

4. Physical Measurements

- Measure the wall thickness around fracture surfaces and any damaged areas. If corrosion is identified near or around the fracture surfaces, a "corrosion map" including reference points should be produced detailing the extent of the corrosion on the surfaces and the wall thicknesses in those areas. Measurements may be made using straight beam ultrasonic testing from the external surface.
- Record any markings detected on the inside or outside surfaces of the shell. Record name plate data.
- Measure rupture lengths tip-to-tip.
- Measure the shortest circumferential distance from each fracture origin to the nearest longitudinal weld and any attachment weld or structural discontinuity, such as nozzles, saddle supports, tubesheets, etc.
- Measure the axial distance from each fracture origin to the nearest circumferential weld, if any, and any attachment weld or structural discontinuity.
- Map wall thickness of each sample within 12 inches of each rupture origin using straight beam ultrasonic testing. Measurements will be taken on a 2-inch square grid pattern that is centered on the fracture origin.

5. Shell Course Match Marking

Suitable markings shall be made on external surfaces of shell sections on both sides of the separation at the circumferential weld to permit accurate recreation of the shell alignment of the two sections at the time of failure.

A minimum of 3 business days notice shall be given to all parties to this agreement to allow the opportunity to be present and determine the location of the shell course match markings. Mutual agreement of the parties present is required prior to making shell course markings.

Part 2. Laboratory Examination

The 6600-E exchanger will be submitted to a laboratory acceptable to all parties in as found condition for disassembly, further testing and evaluation. The parties will agree on a protocol

BETA LAB NO. M10198, TESORO LS2 AND LS2/CS2 TEE FINDINGS PART: 6600-E HEAT EXCHANGER, LS2 22 IN, 36.5 IN MOUNTS, LS2 T2L SEM FRACTOGRAPHY AND PART 22 LS2-CS2 TEE FINDINGS PARTS 16-1 AND 22	TESORO REFINING AND MARKETING COMPANY ANACORTES REFINERY 10200 W. MARCH POINT ROAD T91WA4428 ANACORTES, WA 98221	CUSTOMER P.O. No.: 4501667904
		DATE: OCTOBER 13, 2010
		PAGE 47 OF 56

LABORATORY REPORT

Tesoro Exchanger E Failure Examination Protocol

for disassembly and cutting prior to any such work. Some of the work below is redundant with the field inspections listed above and may be eliminated with concurrence from all parties if the field data is thought sufficient.

The laboratory will provide a schedule of activities and testing 3 business day prior to commencing any work to the parties to this agreement in order to receive the opportunity to be present and observe testing.

1. Material Preparation for Shipment and Receipt

- All materials shall be photographed as found, once secured for shipping, and as received.
- The 6600-E exchanger will be submitted to the laboratory in as found condition for disassembly, further testing and evaluation. Spray fracture surfaces with clear lacquer (Krylon or Rustoleum clear spray) dissolvable in acetone to protect fracture surfaces from corrosion. Fracture surfaces shall be protected from mechanical damage during transport (e.g. a split rubber hose pressed along the edge of the sample).
- The exchanger will be secured to a transport trailer, and protected by a hard cover (e.g. wood box or "conex" with the bottom removed) with a door secured by a tamperproof seal prior to shipment.
- An inspection of the tamperproof seal will be documented on the chain of custody prior to shipment. The chain of custody will be signed by the representative of each interested party indicating the exchanger is ready for shipment
- Shipping details will be provided to the lab of choice.
- A representative of the laboratory will be present take receipt of the exchanger, photograph the as received condition and document any apparent shipping damage.
- The exchanger and any samples collected will be stored in a secure indoor location.

Laboratory NDE Examinations

1. Take caliper readings for thickness of middle of plate and all edges and document. If there is pitting corrosion damage, pits within the area of interest will be counted and the pit length, width and depth will be recorded. Take macro hardness readings of each plate. If there is noticeable scale, take scale samples and preserve in clean glass jar.
2. Inspect the failed section for isolated cracks or colonies of cracks using nondestructive testing techniques. Carbon steel surfaces surrounding the rupture should be cleaned with an appropriate non-abrasive cleaner and subsequently inspected using a wet fluorescent magnetic particle inspection (WFMT) method. The circumferential weld should be examined by dye penetrant (PT) and WFMT (this weld was backcladded with austenitic material and there will be a carbon steel heat affected zone on one side and austenitic cladding on the other side of the weld).
3. Visually examine the fracture surfaces in detail to identify the characteristics of the fracture, the presence of any defect or anomaly, and the failure initiation point(s). Utilize a suitable

BETA LAB NO. M10198, TESORO LS2 AND LS2/CS2 TEE FINDINGS PART: 6600-E HEAT EXCHANGER, LS2 22 IN, 36.5 IN MOUNTS, LS2 T2L SEM FRACTOGRAPHY AND PART 22 LS2-CS2 TEE FINDINGS PARTS 16-1 AND 22	TESORO REFINING AND MARKETING COMPANY ANACORTES REFINERY 10200 W. MARCH POINT ROAD T91WA4428 ANACORTES, WA 98221	CUSTOMER P.O. No.: 4501667904
		DATE: OCTOBER 13, 2010
		PAGE 48 OF 56

LABORATORY REPORT

Tesoro Exchanger E Failure Examination Protocol

method to thoroughly document the fracture surface including dimensional documentation. Suitable methods to document the fracture surface include, but are not limited to, the following:

- Foil method
- Photographs of macroscopic examination

Marking and Sample Selection for Analysis

1. Examine each tagged sample for areas where sections will be removed for further detailed analysis. The laboratory metallurgist with concurrence of all parties should determine the areas to sample for all analyses. Include areas directly opposite of any fractured weld/area to get both sides of the fracture.
2. Mark all areas chosen for further examination and label ID and OD. Include specimen side to be exposed when mounted.
3. Document those areas with macrophotographs, showing areas to be removed, ID tag, and reference measurements.
4. Mark all remote areas to be sampled for general chemical analysis and mechanical tests, including base metal, welds, and Heat Affected Zones (HAZ).

Fractographic/Metallographic Examination

1. Saw cutout sections to be mounted or looked at with Macroscope / optical light stereoscope, maintaining tag traceability and side to be examined.
2. Examine specimens with Macroscope and take pictures. If sample fracture surface was corroded before spraying with clear lacquer, then cut in half and keep one half and then take other half and remove lacquer with acetone and clean surface with a cleaning solution such as Endox. Then, examine specimens with Macroscope and take pictures. Retain some of the fracture surface of interest and go to Step 3.
3. Examine un-mounted and unpolished fracture surfaces of interest in an SEM at 5, 50, 100, 500, 1000 and 5000X to look for possible / likely initiation sites and clearly describe the fracture surface morphology (intergranular, cleavage, microvoid coalescence). Any deposit areas should be analyzed with EDS analysis.
4. Cold mount sample pieces in areas of interest for metallography.
5. Etch control numbers on each mount corresponding to original tags.

BETA LAB NO. M10198, TESORO LS2 AND LS2/CS2 TEE FINDINGS PART: 6600-E HEAT EXCHANGER, LS2 22 IN, 36.5 IN MOUNTS, LS2 T2L SEM FRACTOGRAPHY AND PART 22 LS2-CS2 TEE FINDINGS PARTS 16-1 AND 22	TESORO REFINING AND MARKETING COMPANY ANACORTES REFINERY 10200 W. MARCH POINT ROAD T91WA4428 ANACORTES, WA 98221	CUSTOMER P.O. No.: 4501667904
		DATE: OCTOBER 13, 2010
		PAGE 49 OF 56

LABORATORY REPORT

Tesoro Exchanger E Failure Examination Protocol

6. Grind and polish the surface of each sample using a series of progressively finer grit papers and polishing wheels to obtain a surface suitable for examination under a metallurgical microscope with magnification at 50X, 100X, 200X, 500X, 1000X, and 1500X.
7. Examine each mount in the unetched condition under a Macroscope at 5 to 50X magnification.
8. Take photomicrographs and document any areas of interest. Areas of interest may include:
 - At or near the fracture origin
 - Fracture surfaces
 - Weld seams and HAZs
 - Anomalies
 - Areas with indications of defects or cracks identified through visual and/or non-destructive testing
 - Areas exhibiting "typical" microstructures of the base metal, weld metal, and heat-affected zone.
9. Examine each mount under a metallurgical microscope for a higher magnification view of any areas on the sample.
10. Photograph any areas of interest.
11. Surface etch each mount with a Nital 5% etch solution (for A515-70) and reexamine using both the macro and microscopes.
12. Mounts that contain alloys other than carbon steel may require different etch solutions or techniques.
13. Photograph and document all areas of interest.
14. Decide if any mounts are to be further examined using a Scanning Electron Microscope (SEM) either in the etched or unetched condition in the case of the mounts.
15. Photograph and document all areas of interest.
16. Perform EDS analysis of any scale or weld/base metal zone as required on the polished mount samples.
17. All weld joint cross section specimens should be given a series of microhardness tests starting in base metal and traveling through the weld HAZ and weld metal using a protocol to be provided by the lag. If there is a fracture surface in cross section in a mount, take a microhardness reading adjacent to the fracture surface. Then take microhardness on the mounted specimen that came from the other side of the particular fracture location and perform a microhardness adjacent to the fracture surface.

BETA LAB NO. M10198, TESORO LS2 AND LS2/CS2 TEE FINDINGS PART: 6600-E HEAT EXCHANGER, LS2 22 IN, 36.5 IN MOUNTS, LS2 T2L SEM FRACTOGRAPHY AND PART 22 LS2-CS2 TEE FINDINGS PARTS 16-1 AND 22	TESORO REFINING AND MARKETING COMPANY ANACORTES REFINERY 10200 W. MARCH POINT ROAD T91WA4428 ANACORTES, WA 98221	CUSTOMER P.O. No.: 4501667904
		DATE: OCTOBER 13, 2010
		PAGE 50 OF 56

LABORATORY REPORT

Tesoro Exchanger E Failure Examination Protocol

During the course of examination metallographic samples should be examined to characterize and validate any issues specific to the failure such as:

- *Material specification, grade, and heat treatment*
- *Weld seam in area of fracture*
- *Weld seam in un-affected area*
- *Degradation of microstructure from service conditions*
- *Corrosion*
- *Indications of outside force damage*
- *Differences in microstructure based on op. temperature (which varies along the length of the shell)*

Mechanical Properties

Testing should be performed to determine the mechanical properties of the heat exchanger and any appurtenances. Mechanical properties of test specimens should not be taken from areas of the heat exchanger that have been plastically deformed as a result of the failure but shall include tests from all components within 2 feet of the fracture surfaces. These mechanical tests should at least include the following:

- Tensile Testing
- Charpy V-notch Impact Testing
- Chemical Analysis

1. Tensile Testing

Tensile test specimens should be prepared and tested in accordance with ASTM A370 (Mechanical Testing of Steel Products) for the shell base metal and weld seams to measure yield strength, ultimate tensile strength, and elongation. The shell base metal should, at a minimum be tested in the transverse direction, and weld seam specimens should be taken across the weld seam.

2. Charpy V-notch Impact Testing

Charpy V-notch (CVN) specimens should be prepared and tested in accordance with ASTM E23 (Notched Bar Impact Testing of Metallic Materials) to determine the toughness characteristics of in the transverse direction. Transition curves shall be produced with three (3) specimens at each temperature. Results from CVN testing may be reported in some or all of the following forms depending on the testing results:

- Upper-Shelf Energy (in ft-lbs and SI units)
- Lower-Shelf Energy (in ft-lbs and SI)
- Ductile-to-Brittle Transition Temperature (50% in °F) determined from graphical representation of testing results
- Fracture Appearance Transition Temperature (in °F) corresponding to 50 % shear

BETA LAB NO. M10198, TESORO LS2 AND LS2/CS2 TEE FINDINGS PART: 6600-E HEAT EXCHANGER, LS2 22 IN, 36.5 IN MOUNTS, LS2 T2L SEM FRACTOGRAPHY AND PART 22 LS2-CS2 TEE FINDINGS PARTS 16-1 AND 22	TESORO REFINING AND MARKETING COMPANY ANACORTES REFINERY 10200 W. MARCH POINT ROAD T91WA4428 ANACORTES, WA 98221	CUSTOMER P.O. No.: 4501667904
		DATE: OCTOBER 13, 2010
		PAGE 51 OF 56

LABORATORY REPORT

Tesoro Exchanger E Failure Examination Protocol

- Lateral expansion (to measure notch toughness)
 In some steels it may be difficult to measure percent shear because of "woody" fracture surfaces. In these cases it would be more appropriate to use lateral expansion and absorbed energy measurements to obtain a more accurate transition temperature.

Optional: If the charpy transition curves or fracture appearance displays any deviation from normal A515-70 material behavior, fracture mechanics testing should be performed to determine both static and dynamic fracture toughness. There are several standards and specimens that could be used and the appropriate test(s) should be agreed upon by all parties.

3. Chemical Analysis

Chemistry samples representative of all components within two feet of the fracture surfaces shall be taken and analyzed in accordance with ASTM Specification A20 / A20M compared to ASME Section II material specifications. Perform Leco analysis for carbon. A determination of carbon equivalent for each test shall be made.

Energy dispersive spectroscopy (EDS) and either x-ray diffraction (XRD) or x-ray photoelectron spectroscopy (XPS) analyses may be used to determine elements and compounds present in surface deposits that were collected during the visual examination if considered germane to the investigation. Other suitable test methods may also be used.

High Temperature Hot Hydrogen Testing (OPTIONAL)

If the initial analysis appears to indicate HTHA, then have small specimens removed and analyzed per the Materials Property Council (MPC) Moly-Hy Joint Industry Program protocol at University of Tennessee. This protocol involves cryo-cracking (cryogenic induced fracture after immersing in liquid nitrogen) after machining a small notch in the material (probably close to fracture surface) and then examining the fracture surface with SEM at high magnification (5,000 – 15,000X). Another part of the protocol is to measure the non-diffusible hydrogen to infer the CH₄ content.

Laboratory Results Reporting/Sample Retention

1. All laboratory tests, including photographs or sketches, should be documented and summarized in a complete lab report. No analysis or conclusions shall be provided.
2. The Laboratory Report should be signed by a P.E from the laboratory.
3. An electronic version (e.g. pdf, jpg) report shall be distributed by the third party conducting these examinations to all parties simultaneously within 72 hours of completion. No party shall have the opportunity to review any results in advance of the other parties. Any part requesting clarification or correction of anything in the report shall submit their request to all parties

BETA LAB NO. M10198, TESORO LS2 AND LS2/CS2 TEE FINDINGS PART: 6600-E HEAT EXCHANGER, LS2 22 IN, 36.5 IN MOUNTS, LS2 T2L SEM FRACTOGRAPHY AND PART 22 LS2-CS2 TEE FINDINGS PARTS 16-1 AND 22	TESORO REFINING AND MARKETING COMPANY ANACORTES REFINERY 10200 W. MARCH POINT ROAD T91WA4428 ANACORTES, WA 98221	CUSTOMER P.O. No.: 4501667904
		DATE: OCTOBER 13, 2010
		PAGE 52 OF 56

LABORATORY REPORT

Tesoro Exchanger E Failure Examination Protocol

4. All samples that are cut, whether used or not and all samples analyzed shall be saved and stored in a manner that minimizes corrosion, by retaining in a container filled with desiccant or wrapping in plastic, etc.
5. The chain of custody form should be signed at all stages where the samples are handled within the lab or removed from the lab for any reason. Any markings/tags should be visible and retained.

James Darnell
 Vice President, Health and Safety
 Tesoro Companies



 Signature 5 May 2010
 Date

Robert Parker
 Compliance Manager
 Division of Occupational Safety and Health

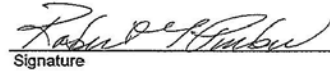

 Signature 5-17-10
 Date

Robert J. Hall
 Investigator-in-Charge
 U.S. Chemical Safety Board



 Signature 5-15-10
 Date

BETA LAB NO. M10198, TESORO LS2 AND LS2/CS2 TEE FINDINGS PART: 6600-E HEAT EXCHANGER, LS2 22 IN, 36.5 IN MOUNTS, LS2 T2L SEM FRACTOGRAPHY AND PART 22 LS2-CS2 TEE FINDINGS PARTS 16-1 AND 22	TESORO REFINING AND MARKETING COMPANY ANACORTES REFINERY 10200 W. MARCH POINT ROAD T91WA4428 ANACORTES, WA 98221	CUSTOMER P.O. No.: 4501667904
		DATE: OCTOBER 13, 2010
		PAGE 53 OF 56

LABORATORY REPORT

Tesoro Exchanger E Failure Examination Protocol
Addendum-1: Additional Work for Part 1 of Protocol

Part 1. Field Visual and Nondestructive Examination

All field visual and nondestructive tests shall be appropriately documented indicating examinations performed, scope of examinations, test equipment used in examinations, results of testing and the qualifications of the examiner as appropriate. All reports will be signed and dated by the examiner(s). Data reports shall be distributed by the third party conducting these examinations to all parties simultaneously. No party shall have the opportunity to review any data results in advance of the other parties. Any party requesting clarification or correction of anything in the report shall submit their request to all parties. Data generated as a result of the execution of this protocol will be shared with all parties to the agreement simultaneously. Visual inspection reports, analysis or conclusion will not be shared.

Field Visual and Nondestructive Examination

Current work in the section:

- 3. Field Crack Detection Ultrasonic Testing

Conduct ultrasonic examination adjacent to all fracture surfaces using techniques suitable for stress corrosion cracking or other potential service cracking mechanisms. Phased array is preferred for macro-cracking and AUBT is preferred for fissuring due to HTHA.

Additional work recommended for this section:

Exchanger E: Perform phased array ultrasonic inspection on all full penetration welds located between the point of failure and the shell to tubesheet flange weld with the exception of nozzle welds. Data reports for the additional work will be provided to all parties simultaneously within 24 hours of completion of the inspection.

James Darnell
 Vice President, Health and Safety
 Tesoro Companies

 Signature _____ Date 20 MAY 2010

Robert Parker
 Compliance Manager
 Division of Occupational Safety and Health

 Signature _____ Date 5-20-10
 FOR BOB PARKER

Robert J. Hall
 Investigator-in-Charge
 U.S. Chemical Safety Board

 Signature _____ Date 5-20-10

BETA LAB NO. M10198, TESORO LS2 AND LS2/CS2 TEE FINDINGS	TESORO REFINING AND MARKETING COMPANY ANACORTES REFINERY 10200 W. MARCH POINT ROAD T91WA4428 ANACORTES, WA 98221	CUSTOMER P.O. No.: 4501667904
PART: 6600-E HEAT EXCHANGER, LS2 22 IN, 36.5 IN MOUNTS, LS2 T2L SEM FRACTOGRAPHY AND PART 22 LS2-CS2 TEE FINDINGS PARTS 16-1 AND 22		DATE: OCTOBER 13, 2010
PAGE 54 OF 56		

LABORATORY REPORT

Tesoro Exchanger E Failure Examination Protocol Addendum – 3: Revisions/Lab Clarifications

This Addendum-3 to Exchanger E Failure Examination Protocol sets forth revisions to the original Inspection Protocol document.

1. The requirement to take caliper readings for thickness in the middle of the plate is deleted.
2. The requirement to take macro hardness readings on each plate will only apply to test plates supplied to the laboratory and not plates which remain attached to the heat exchanger.
3. The WFMT and PT shall be applied only to the ID surfaces in the vicinity of the fractures.
4. The fracture surfaces will be documented but the identification of the initiation point, the fracture mode and the interpretation of the fracture will be the responsibility of the signatory parties or their technical representatives.
5. Dimensional documentation of all fracture surfaces will be by inclusion of a scale in all photos.
6. The laboratory, acting as a referee laboratory, will be supplied the locations to take the test samples and the type of test and test parameters to be performed at each location on the test sample, i.e. magnification, hardness load/test method. The signatory parties or their technical representatives that are present in the laboratory at the time shall make those decisions and give that information directly to the laboratory. Comments from other technical experts will be considered and factored into the signatory parties or their technical representative's decisions but all decisions on protocol or samples shall remain as decisions of the signatory parties or their representatives.
7. The requirement for mounting samples on each side of any fractured weld /area will apply where convenient from the samples already cut out as of this date and will not apply to material still attached to the heat exchanger.
8. Since the fracture surfaces were not coated with any lacquer the requirement to cut each fracture sample in half, keeping one as is and cleaning only one half will not apply.
9. The acceptable cleaning methods for the SEM evaluation of the fracture surfaces are cathodic cleaning in mild alkaline or acid solution or alternatively Alconox and inhibited acid cycles. There is always a risk that extensive field corrosion has consumed the damage profile. One sample will be cleaned and evaluated in the SEM at any given time.
10. All magnifications listed in the test protocol are for equipment capability and the exact magnification and area of interest for all photomicrographs will be will be the responsibility of the signatory parties or their technical representatives present in the lab at the time.
11. A 2 % Nital etch solution is acceptable for use.
12. Because of all the deformation in the vicinity of the fractures the requirement to take the mechanical test specimens within 2 feet of the fractures is deleted.

BETA LAB NO. M10198, TESORO LS2 AND LS2/CS2 TEE FINDINGS PART: 6600-E HEAT EXCHANGER, LS2 22 IN, 36.5 IN MOUNTS, LS2 T2L SEM FRACTOGRAPHY AND PART 22 LS2-CS2 TEE FINDINGS PARTS 16-1 AND 22	TESORO REFINING AND MARKETING COMPANY ANACORTES REFINERY 10200 W. MARCH POINT ROAD T91WA4428 ANACORTES, WA 98221	CUSTOMER P.O. No.: 4501667904
		DATE: OCTOBER 13, 2010
		PAGE 55 OF 56

LABORATORY REPORT

Tesoro Exchanger E Failure Examination Protocol
Addendum – 3: Revisions/Lab Clarifications

13. The tensile and impact testing in the transverse direction is interpreted as transverse to the original plate rolling direction.

14. The requirement to simultaneously distribute the report within 72 hours of completion is deleted and the parties agree to a level 2 report, which contains descriptive text and captioned photos with the resultant assembly time being a function of the amount of data obtained but is typically 2-3 weeks. Any signatory party, its representative, or other party permitted to witness the laboratory testing may have the opportunity to see the data so long as there is no disruption to lab work but no one can have or make any copies of the laboratory work product prior to the Laboratory issuing the test report to the signatory parties.

James Darnell
 Vice President, Health and Safety
 Tesoro Companies

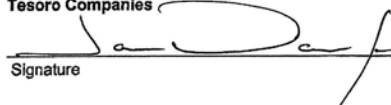
 _____ 7-6-10
 Signature Date

Robert Parker
 Compliance Manager
 Division of Occupational Safety and Health

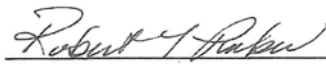
 _____ 7-6-10
 Signature Date

Robert J. Hall
 Investigator-in-Charge
 U.S. Chemical Safety Board

 _____ 7-6-10
 Signature Date

BETA LAB NO. M10198, TESORO LS2 AND LS2/CS2 TEE FINDINGS PART: 6600-E HEAT EXCHANGER, LS2 22 IN, 36.5 IN MOUNTS, LS2 T2L SEM FRACTOGRAPHY AND PART 22 LS2-CS2 TEE FINDINGS PARTS 16-1 AND 22	TESORO REFINING AND MARKETING COMPANY ANACORTES REFINERY 10200 W. MARCH POINT ROAD T91WA4428 ANACORTES, WA 98221	CUSTOMER P.O. No.: 4501667904
		DATE: OCTOBER 13, 2010
		PAGE 56 OF 56

LABORATORY REPORT

Attachment2

TEST EQUIPMENT and PROCEDURES

TEST	INSTRUMENT & MODEL	CALIBRATION DUE DATE	BETA No.	LSS PROCEDURE	
				NUMBER & TITLE	REV No.
Failure Analysis	N/A	N/A	N/A	B0069 Failure Analysis	0
Chemical Analysis	Thermo ARL 3460 Optical Emission Spectrometer	Performance check prior to use	BETA 665	B0068 ARL 3460 Optical Emission Spectrometer Analysis	2
SEM/EDS	Amray Scanning Electron Microscope, Model: 1830T4, S/N: 18321002, with IXRF Energy Dispersive X-ray Spectrometer	*	BETA 386 BETA 755	B0064	*
SEM/EDS	Camscan Scanning Electron Microscope, Model: MV2300U, S/N: US0187039/VG0540181U with IXRF Energy Dispersive X-ray Spectrometer and x-ray Optics/AAT Detector	March 14, 2011	BETA 602 BETA 756	B0047 CAMSCAN/IXRF SEM/EDS System	8
Rockwell Hardness	Wilson Rockwell 524T Hardness Tester, Model 83259910	Performance check prior to use	BETA 400	D0027 Wilson Rockwell Model 524T Hardness Tester	5
Rockwell Hardness	NewAge NI300-C Hardness Tester, Model 8150 S/N 951480	Performance check prior to use	BETA 897	D0052	*
Knoop/Vickers Hardness	Buehler Micromet II Digital Microhardness Tester, Model B-D58222	Performance check prior to use	BETA 401	D0028	*
Knoop/Vickers Hardness by Image Analysis	Buehler Micromet II Digital Microhardness Tester, Model B-D58222 with Buehler OmniMet Analysis System Program Version 9.0 Rev 3	Performance check prior to use	BETA 401 BETA 977	D0028	*
Field Hardness	Proceq Equotip Hardness Tester, Model 25-819	Performance check prior to use	BETA 428	D0016	*
Knoop/Vickers, Semi-Macro Vickers Hardness	Instron Tukon 2100B Hardness Tester, Model T2100BR1942	Performance check prior to use	BETA 2006	D0068 Instron Tukon 2100B Hardness Tester	0
Reagent Preparation [^]	N/A	N/A	N/A	C0005 Metallurgical Reagents ▲	7
Linear Measurements by Optical Methods	LECO PMG-3 Inverted Metallograph with Buehler OmniMet Analysis System Program Version 9.0 Rev 3	6/1/2011	BETA 419 BETA 977	D0065	0
Average Grain Size	LECO PMG-3 Inverted Metallograph with Buehler OmniMet Analysis System Program Version 9.0 Rev 3	*	BETA 419 BETA 977	D0066	*
Dimensional	Starrett Micrometer Number 222	9/09/2010	BETA DLC-C-094	NA	NA
Dimensional	Starrett Vernier S/N 120 A	*	BETA 2005	NA	NA
Dimensional	Mitutoyo Digital Micrometer 342-361	*	BETA 884	NA	NA
Mass	Mettler AE-100 S/N C-31383	*	BETA 113	NA	NA
Mass	Sartorius LP-6200S	*	MLL 0009	NA	NA

*Denotes procedures or instruments not used in this report

▲ Etchant 5-1, 2% Nital